

Concrete Engineering Series 82

**Recommendations for Design and Construction of High
Performance Fiber Reinforced Cement Composites
with Multiple Fine Cracks (HPFRCC)**

March, 2008

Japan Society of Civil Engineers

Preface

When subjected to an increasing tensile load, High Performance Fiber Reinforced Cement Composites with Multiple Fine Cracks (herein after referred to as HPFRCC) show large tensile deformation. This tensile deformation is associated with the successive formation of fine cracks roughly 0.1mm wide. The increase in crack number rather than crack width is the reason for such a large uniformly distributed tensile deformation. This phenomenon is what makes HPFRCC particularly interesting.

As HPFRCC materials can take tensile loading, are able to control cracks in a narrow range and exhibit large tensile deformation and ductility, there is a wide range of possible applications. Some of these include usage as members with reinforcing steel and surface repair materials for concrete structures.

The name "High Performance Fiber Reinforced Cement Composites" comes from the excellent performance under tensile loading conditions. It is also known as "Strain Hardening Cement-based Composites" (SHCC) due to the tensile strain-hardening properties. "Engineered Cementitious Composites" (ECC) are typical examples of the same type of material.

In order to gain approval for HPFRCC in the construction industry, a subcommittee within the Concrete Committee of the Japan Society of Civil Engineers was formed in September 2005. They were charged with the task of drafting the recommendations for design and construction. The recommendations were reviewed by the standing committee and approved in December of 2006.

The recommendations propose methods for uniaxial tensile tests and crack width measurements. Advisory members from the international researchers provide technical input through the RILEM technical committee TC-HFC.

As HPFRCC have the ability to allow fine crack formation under loading, the recommendations cover the following aspects:

- Design values for tensile strength, tensile strain and crack width,
- Structural performance verification taking into account tensile strength and strain, and
- Resistance to environmental loading taking into account crack width.

We look forward to the ready integration of HPFRCC into the construction industry and hope HPFRCC will find variety of applications. We also hope the recommendations are instrumental in the design and construction of this versatile material. Finally, I would extend my sincere appreciation for the secretaries general Dr. Hiroshi Yokota and Dr. Noboru Sakata and for those involved in the preparation of the recommendations.

March 2008

Prof. Keitetsu Rokugo, Chairperson
Sub-Committee, Recommendations for Design and Construction of HPFRCC
Concrete Committee, Japan Society of Civil Engineers

Concrete Committee, Japan Society of Civil Engineer

Member (2005 and 2006 F.Y.)

Advisors

Shoji Ikeda, Hajime Okamura, Yoshio Kakuta, Wataru Koyanagi, Eiichi Tazawa, Tada-aki Tanabe, Shigeyoshi Nagataki, Atsuhiko Machida, Takeshi Miura

Chairman: Kyuichi Maruyama
General Secretary: Hiroshi Yokota

Members

Koichi Ayuta	Tadayoshi Ishibashi	Yasuo Inokuma	Zhishen Wu	Tamon Ueda
Taketo Uomoto	Kimitaka Uji	Sakae Ushijima	Yuichi Uchida	Hidetaka Umehara
Takao Endo	Takashi Ohura	Masayasu Ohtsu	Koji Otsuka	Nobuaki Otsuki
Satoshi Okazawa	Tsutomu Kanazu	Hiroataka Kawano	Toshiharu Kishi	Katsuro Kokubu
Takayuki Kojima	Hiroshi Kojima	Etsuro Sakai	Koji Sakai	Kenji Sakata
Tsutomu Sato	Ryoichi Sato	Hiroshi Shima	Takumi Shimomura	Masami Shoya
Kazuo Suzuki	Motoyuki Suzuki	Hiroshi Seki	Shigeyuki Sogo	Koji Takewaka
Takao Chikada	Yukikazu Tsuji	Tomoaki Tsutsumi	Masamichi Tezuka	Rokuro Tomita
Kazuyuki Torii	Hikaru Nakamura	Toyoharu Nawa	Junichiro Niwa	Yoshinobu Nobuta
Chikanori Hashimoto	Atsushi Hattori	Tetsuo Harada	Takeshi Higai	Masao Hirasawa
Tsutomu Fukute	Koichi Maekawa	Yasunori Matsuoka	Hiromichi Matsushita	Tetsuya Mishima
Toyoaki Miyagawa	Ayaho Miyamoto	Hiroshi Mutsuyoshi	Hidenori Morikawa	Atsushi Yamazaki
Takeshi Yamato	Yasuhiko Yamamoto	Hiromichi Yoshikawa	Toshio Yonezawa	Keitetsu Rokugo
Yashumitsu Watanabe				

Concrete Committee, Japan Society of Civil Engineers

Sub-Committee, Recommendations for Design and Construction of HPFRCC

Chairperson: Keitetsu Rokugo (Gifu University)

Secretary: Hiroshi Yokota (Port and Airport Research Institute)

Members of Sub-Committee

Tadashi Inakuma (JR Tokai Consultants)

Taketo Uomoto (The University of Tokyo)

Yuichi Uchida (Gifu University)

Masaru Okamoto (Railway Research Institute)

Yasushi Kamihigashi (Japan Road Association)
Cold Region)

Hiroataka Kawano (Kyoto University)

Minoru Kunieda (Nagoya University)

Takefumi Shindo (Taisei Corporation)

Masaki Seki (Central Japan Railway Company)

Jun-ichiro Niwa (Tokyo Institute of Technology)

Koichi Maekawa (The University of Tokyo)

Takashi Matsumoto (Hokkaido University)

Hiroshi Mitamura (Civil Engineering Research Institute for

Toyoaki Miyagawa (Kyoto University)

Shinichi Miyazato (Kanazawa Institute of Technology)

Members of Trustors

Co-secretary: Noboru Sakata (Kajima Corporation)

Members

Tomohiro Ohishi (Futase Corporation)

Shizuo Kato (Docon Corporation)

Tetsushi Kanda (Kajima Corporation)

Takuya Konishi (Toyobo Corporation)

Katsuya Kobayashi (Chodai Corporation)

Michihiro Sakurada (PS Mitsubishi Corporation)

Kumiko Suda (Kajima Corporation)

Hisashi Terada (The Japan Steel Works, Ltd)

Hiroyuki Nakagawa (Kindai Sekkei Consultant, Inc.)

Masahiko Harada (Japan Consultant Corporation)

Mamoru Fujikawa (Kindai Sekkei Consultant, Inc.)

Yasuhiro Fujimoto (Sugiyama Consultants)

Hideki Hoshiro (Kuraray Corporation)

Akihiro Hori (Denki Kagaku Kogyo K.K.)

Shoji Matsuo (Tekken Corporation)

Akihito Miyoshi (Dobokugijutsu Consultant)

Naoharu Morii (Deros, Ltd)

Tadaaki Watanabe (Hokubu Corporation)

Members of English Publication Working Group

Chairperson: Takashi Matsumoto (Hokkaido University)
Vice chairperson: Yuichi Uchida (Gifu University)

Members

Toshimichi Ichinomiya (Kajima Corporation) Hideki Hoshiro (Kuraray Corporation)
Tetsushi Kanda (Kajima Corporation) Shinichi Miyazato (Kanazawa Institute of Technology)
Minoru Kunieda (Nagoya University)

Members of Design Working Group

Chairperson: Kumiko Suda (Kajima Corporation)
Vice chairperson: Yuichi Uchida (Gifu University)

Members

Toshimichi Ichinomiya (Kajima Corporation) Mamoru Fujikawa (Kindai Sekkei Consultant, Inc.)
Masaru Okamoto (Railway Research Institute) Yasuhiro Fujimoto (Sugiyama Consultants)
Shizuo Kato (Docon Corporation) Hiroshi Mitamura (Civil Engineering Research Institute for
Cold Region)
Katsuya Kobayashi (Chodai Corporation) Shinichi Miyazato (Kanazawa Institute of Technology)
Hisashi Terada (The Japan Steel Works, Ltd) Akihito Miyoshi (Dobokugijutsu Consultant)
Hiroyuki Nakagawa (Kindai Sekkei Consultant, Inc.) Akihisa Masuda (Tekken Corporation)
Masahiko Harada (Japan Consultant Corporation) Tadaaki Watanabe (Hokubu Corporation)
Ichiro Fukuda (Kajima Corporation)

Members of Materials and Constructions Working Group

Chairperson: Tetsushi Kanda (Kajima Corporation)
Vice chairperson: Tadashi Inakuma (JR Tokai Consultants)

Members

Tomohiro Ohishi (Futase Corporation) Masaru Fujishiro (Kajima Corporation)
Atsushi Kawamata (Tekken Corporation) Hideki Hoshiro (Kuraray Corporation)
Takuya Konishi (Toyobo Corporation) Akihiro Hori (Denki Kagaku Kogyo K.K.)
Noboru Sakata (Kajima Corporation) Shoji Matsuo (Tekken Corporation)
Michihiro Sakurada (PS Mitsubishi Corporation) Takashi Matsumoto (Hokkaido University)
Shiro Tomoe (Kajima Corporation) Naoharu Morii (Deros, Ltd)
Takanori Hiraishi (Kajima Corporation)

Advisors

Folker Wittmann	Germany	Victor Li	U.S.A
Gregor Fischer	Denmark	Toshiyuki Kanakubo	Tsukuba University
Henrik Stang	Denmark	Hiroshi Fukuyama	Building Research Institute
Mohamed Maalej	Singapore	Kyuichi Maruyama	Nagaoka University of Technology,
Petr Kabele	Czech Republic	Hirozo Mihashi	Tohoku University
Sarah Billington	U.S.A		

Recommendations for Design and Construction of High Performance Fiber Reinforced Cement Composites with Multiple Fine Cracks (HPFRCC)

CONTENTS

Chapter 1 General	1
1.1 Scope	
1.2 Terminology	
1.3 Notation	
Chapter 2 Design Basics	5
2.1 General	
2.2 Design service life	
2.3 Principles of performance verification	
2.4 Safety factors	
Chapter 3 Material Properties for Design	8
3.1 General	
3.2 Strength and strain	
3.2.1 Characteristic values	
3.2.2 Tensile yield strength	
3.2.3 Tensile strength	
3.2.4 Ultimate tensile strain	
3.2.5 Compressive strength	
3.3 Stress-strain curves	
3.3.1 Tensile stress-strain curve	
3.3.2 Compressive stress-strain curve	
3.4 Young's modulus	
3.5 Poisson's ratio	
3.6 Thermal characteristics	
3.7 Shrinkage	
3.8 Creep	
3.9 Fatigue	
3.10 Maximum crack width	
Chapter 4 Loads	25
4.1 General	
Chapter 5 Structural Analysis	26
5.1 General	
5.2 Response value calculation for safety verification	
5.3 Response value calculation for serviceability verification	
Chapter 6 Safety Verification of Structures	27
6.1 General	
6.2 Examination of safety against bending moment and axial forces	
6.2.1 Design capacity of member cross section	
6.2.2 Structural details	
6.3 Examination of safety against shear forces	
6.3.1 General	

- 6.3.2 Design shear force for linear members
- 6.3.3 Design shear capacity of linear members
- 6.3.4 Examination of punching shear of planar members
- 6.3.5 Design member forces in planar members subjected to in-plane forces
- 6.3.6 Design capacity of planar members subjected to in-plane forces
- 6.3.7 Design shear transfer capacity
- 6.3.8 Structural details
- 6.4 Examination of safety against torsion
- 6.5 Examination of safety against fatigue
 - 6.5.1 General
 - 6.5.2 Verification of safety against fatigue
 - 6.5.3 Design variable force and equivalent number of cycles
 - 6.5.4 Stress calculation due to variable loads
 - 6.5.5 Design shear fatigue capacity of members
- 6.6 Examination of safety against rigid body stability

Chapter 7 Serviceability Verification of Structures 38

- 7.1 General
- 7.2 Calculation of stress and strain
- 7.3 Stress limit value
- 7.4 Strain limit value
- 7.5 Examination of tensile strain
- 7.6 Examination of cracking
 - 7.6.1 General
 - 7.6.2 Permissible crack width
 - 7.6.3 Classification of environmental conditions
 - 7.6.4 Examination of bending cracks
 - 7.6.5 Examination of shear cracks
 - 7.6.6 Examination of torsional cracks
 - 7.6.7 Structural details
- 7.7 Examination of deflection and displacement
- 7.8 Examination of vibration

Chapter 8 General Structural Details 47

- 8.1 General
- 8.2 Concrete cover
- 8.3 Spacing of steel bars
- 8.4 Development of steel bars
 - 8.4.1 General
 - 8.4.2 Development performance
 - 8.4.3 Critical sections to check development of reinforcement
 - 8.4.4 Development length for reinforcement
 - 8.4.5 Basic development length
- 8.5 Splices in reinforcement
 - 8.5.1 General
 - 8.5.2 Lap splices
 - 8.5.3 Performance of splices
- 8.6 Construction joint

Chapter 9 Verification for Resistance to Environmental Actions 53

- 9.1 General
- 9.2 Verification of steel corrosion due to carbonation

- 9.3 Verification of chloride induced steel corrosion
- 9.4 Verification of freezing and thawing damages
- 9.5 Verification of water-tightness
- 9.6 Verification of resistance to chemical attacks
- 9.7 Verification of alkali-aggregate reactions
- 9.8 Verification of fire resistance

Chapter 10 Concreting Work..... 62

- 10.1 General
- 10.2 Materials
 - 10.2.1 Materials in general
 - 10.2.2 Materials for matrix
 - 10.2.3 Water
 - 10.2.4 Reinforcing fibers
 - 10.2.5 Admixtures
- 10.3 Mix proportions
 - 10.3.1 General
 - 10.3.2 Workability
 - 10.3.3 Verification of strength and strain
 - 10.3.4 Representation of mix proportion
- 10.4 Manufacture
 - 10.4.1 Storage
 - 10.4.2 Batching
 - 10.4.3 Mixing
- 10.5 Transportation
- 10.6 Placement
- 10.7 Finishing
- 10.8 Curing
- 10.9 Formwork and shoring
- 10.10 Cold weather concreting
 - 10.10.1 General
 - 10.10.2 Materials and mix proportions
 - 10.10.3 Transportation and placement
 - 10.10.4 Curing
- 10.11 Hot weather concreting
 - 10.11.1 General
 - 10.11.2 Materials and mix proportions
 - 10.11.3 Transportation and placement
 - 10.11.4 Curing
- 10.12 Inspection
 - 10.12.1 General
 - 10.12.2 Inspection for acceptance of constituent materials of HPFRCC
 - 10.12.3 Inspection of production
 - 10.12.4 Inspection for acceptance of HPFRCC
 - 10.12.5 Inspection for acceptance of reinforcement
 - 10.12.6 Inspection of construction
 - 10.12.7 Inspection of structures

Chapter 11 Shotcrete..... 78

- 11.1 General
- 11.2 Materials
 - 11.2.1 Materials in general

11.2.2	Materials for matrix	
11.2.3	Water	
11.2.4	Reinforcing fiber	
11.2.5	Admixtures	
11.2.6	Anchoring	
11.3	Mix proportions	
11.3.1	General	
11.3.2	Workability	
11.3.3	Verification of strength and strain	
11.3.4	Representation of mix proportions	
11.4	Manufacturing	
11.4.1	Storage	
11.4.2	Batching	
11.4.3	Mixing	
11.5	Preparation of concrete surface	
11.6	Transportation	
11.7	Spraying	
11.8	Finishing	
11.9	Curing	
11.10	Inspection	
11.10.1	General	
11.10.2	Inspection for acceptance of constituent materials of HPFRCC	
11.10.3	Inspection of construction equipment	
11.10.4	Inspection during manufacturing	
11.10.5	Inspection of shotcrete placement	
11.10.6	Inspection of reinforcement assembly	
11.10.7	Inspection of sprayed HPFRCC	
11.10.8	Inspection of structures after installation of HPFRCC	

Testing and Evaluation Methods	Testing Method-1
Testing method 1. Preparation of specimen for strength tests		1
Testing method 2. Testing method of uniaxial tensile strength		6
Testing method 3. Testing method of crack width of HPFRCC		11
-Average and maximum crack widths		
Testing method 4. Testing method of crack width of HPFRCC		14
-Variation of crack width		

Appendix	Appendix-1
I Material properties for design		1
I-1 Characteristic values of HPFRCC products		1
II Examination of material properties		3
II-1 Evaluation of width of cracks in HPFRCC		3
II-2 Carbonation resistance of HPFRCC		13
II-3 Chloride ion penetrability to HPFRCC		21
II-4 Steel corrosion of cracked regions of HPFRCC		32
II-5 Freeze-thaw resistance of HPFRCC		42
II-6 Fire resistance of HPFRCC		50
II-7 Long-term durability of reinforcing fibers used in HPFRCC		56
II-8 Tensile performance and size effect of HPFRCC		62
II-9 Examination examples of tensile creep characteristics of HPFRCC		69
III-1 Fatigue durability of HPFRCC		84
III-2 Examination of cover in HPFRCC structures		90

Chapter 1. General

1.1 Scope

(1) This “Recommendations” document provides basic provisions capable of satisfying the performance requirements of structures such as safety, serviceability, recoverability and compatibility to the environment when designing and constructing structures of high performance fiber reinforced cement composites with multiple fine cracks (HPFRCC).

(2) HPFRCC is a composite material comprising a cement-based matrix and short reinforcing fibers and is a highly ductile material exhibiting multiple fine cracks and pseudo strain-hardening characteristics under uniaxial tensile stress. HPFRCC materials dealt with in this “Recommendations” document are those satisfying the following conditions: specimens are prepared with the method specified in the testing method 1, average ultimate tensile strain determined with testing method 2 is more than 0.5 % and average crack width determined with testing method 3 is less than 0.2 mm.

(3) HPFRCC constituents shall be stable and durable throughout the designed service life of structures.

[Commentary] (1) This “Recommendations” document addresses design and construction of structures of high performance fiber reinforced cement composite with multiple fine cracks (HPFRCC). For items excluded from this “Recommendations” document, refer to Standard Specifications for Concrete Structures and related guidelines.

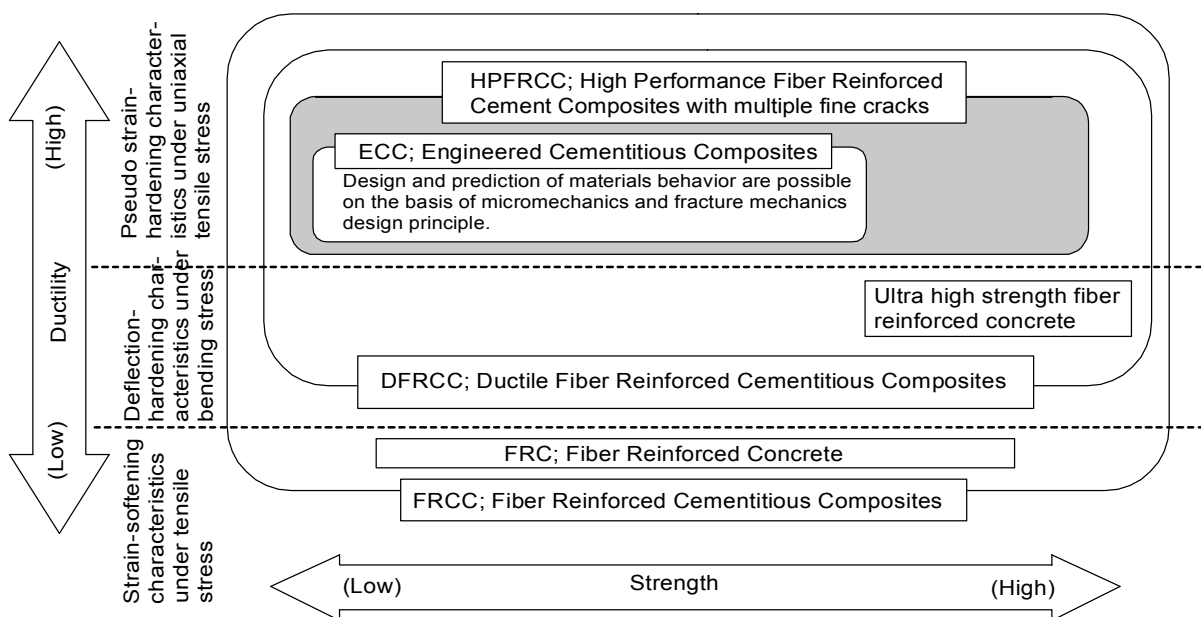


Fig. 1.1.1 Classification of fiber reinforced cementitious composites

(2) HPFRCC is defined as a material that exhibits pseudo strain-hardening characteristics under uniaxial tensile stress among short fiber reinforced cementitious composites – FRCCs, as shown in Fig. 1.1.1. This “Recommendations” document will deal with HPFRCC exclusively.

The pseudo strain-hardening characteristics under direct uniaxial tensile stress are attributed to highly fine and dense multiple crack formation. ECC – Engineered Cementitious Composite proposed by Victor C. Li at the University of Michigan, whose design principle is based on micromechanics and fracture mechanics, is known as a major example of HPFRCC.

The pseudo strain-hardening behavior of HPFRCC under direct uniaxial tensile stress is an increase in tensile stress after first cracking as shown in Fig. 1.1.2 (3). The pseudo strain-hardening behavior is named with particular emphasis on the difference in mechanism with strain-hardening that metallic materials generally show after yielding. Among FRCCs, on the other hand, conventional fiber reinforced concrete – FRC exhibits a decrease in tensile stress after first cracking that is called strain-softening (1), (2), as generally seen in cement-based materials such as cement, mortar and concrete.

Among Ductile Fiber Reinforced Cementitious Composites - DFRCC that includes HPFRCC, some materials do not exhibit pseudo strain-hardening characteristics but show increase in flexural stress with an increase in flexural deformation – deflection-hardening characteristics. The ultra high strength fiber reinforced concrete is a major example of the deflection-hardening materials. The deflection-hardening materials show damage localization at a relatively early stage of deformation depending upon size of the member and loading conditions, and control of

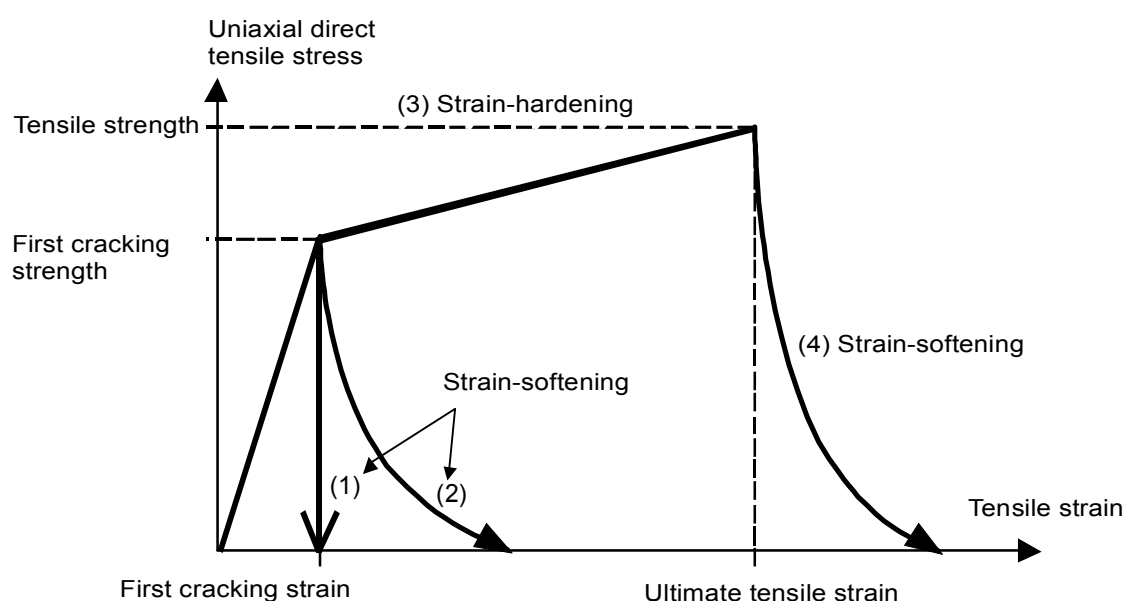


Fig. 1.1.2 Concept of strain-hardening and strain-softening under tensile stress

crack widths is difficult. This is a distinct difference in material property from HPFRCC that exhibits pseudo strain-hardening solely by the material and has a crack width control capability under increasing deformation, and a different method is required when verifying its durability. Thus, the “Recommendations” document will deal only with HPFRCC and exclude the deflection-hardening materials.

The ultimate tensile strain and the averaged crack width are essential performance parameters assuring multiple fine crack formation that enables the pseudo strain-hardening and high durability when HPFRCC is in use.

The scope of the “Recommendations” document includes construction of HPFRCC such as placement and spraying. Placement of HPFRCC includes placement on site, application to factory-made products and manufacturing and transportation in ready-mixed concrete plants as specified for normal concrete. Spraying includes surface covering and sectional recover for repair and strengthening of existing concrete members.

(3) Resistance to environmental actions required for HPFRCC includes carbonation resistance, corrosion of steel reinforcement due to chloride ion ingress, freeze-thaw resistance and water-tightness as required for normal concrete. Materials constituting HPFRCC should be selected to sufficiently ensure the resistance to environmental actions throughout its designed service life. Especially the reinforcing fiber that plays an essential role in ensuring the resistance of HPFRCC to environmental actions should be verified in terms of long-term degradation during the designed service life. The resistance of structure using HPFRCC to environmental actions should be verified according to the Guideline for the Verification of Resistance of Concrete Structures to Environmental Actions (Tentative draft) (Concrete Library 125)

1.2 Terminology

Basic terminology used in this “Recommendations” document is based on Standard Specifications for Concrete Structures – *Structural Performance Verification* and – *Materials and Construction*. Other technical terms are defined as follows.

High performance fiber reinforced cement composite with multiple fine cracks (HPFRCC): Abbreviation of High Performance Fiber Reinforced Cement Composite with multiple fine cracks that fulfills the conditions described in 1.1 (2). With short fiber reinforcement and cement-based materials designed with advanced micromechanics models, it is highly ductile, exhibiting pseudo strain-hardening characteristics under uniaxial tensile stress, with dense and multiple fine crack formation resulting in an ultimate tensile strain of several percent.

Reinforcing fiber: Organic short fibers mixed in the cement matrix.

Matrix material: A group of HPFRCC constituents including cement, powder additives and aggregates.

Premixed material: A dry mixture of matrix materials and reinforcing fiber that are individually

evaluated and then mixed with a specified blender.

Pseudo strain-hardening: A subsequent increase in tensile stress after the first cracking under uniaxial tensile stress.

Tensile yield strength: The stress at the minimum load between first cracking and softening point, corresponding to two inflection points where stress shows changes from an increase to a decrease in the stress-strain curve under uniaxial tensile test.

Characteristic value of tensile yield strength: The tensile yield strength determined as a material property taking into account the scatter of the material's characteristics.

Softening point: A point where the load decreases significantly with the development of single crack width after the formation of multiple cracks under uniaxial tensile test.

Tensile strength: The maximum stress in the stress-strain curve of uniaxial tensile test.

Ultimate tensile strain: The strain at the softening point

Characteristic value of ultimate tensile strain: Ultimate tensile strain determined as a material property taking into account the scatter of the material's characteristics.

Mean crack width: Averaged crack width at the tensile strain corresponding to the characteristic value of the ultimate tensile strain

Maximum crack width: The crack width at the characteristic value of the ultimate tensile strain as determined taking into account variations.

Cracking strength: Stress at first cracking of HPFRCC subjected to tensile stress, where linear elasticity assumption does not hold in the stress-strain relation.

1.3 Notation

Basic notation used in this Recommendation is based on Standard Specifications for Concrete Structures – *Structural Performance Verification and – Materials and Construction*. Other technical symbols are defined as follows.

f_{ty}	: Tensile yield strength of HPFRCC
f_{tyn}	: Experimental value of tensile yield strength of HPFRCC
f_{tyk}	: Characteristic value of tensile yield strength of HPFRCC
f_t	: Tensile strength of HPFRCC
ϵ_{tu}	: Ultimate tensile strain of HPFRCC
ϵ_{tun}	: Experimental value of ultimate tensile strain of HPFRCC
ϵ_{tuk}	: Characteristic value of ultimate tensile strain of HPFRCC
f_v	: Mean tensile strength perpendicular to diagonal crack of HPFRCC
V_f	: Shear strength accommodated by the reinforcing fiber
β_u	: Angle of the diagonal crack

Chapter 2. Design Basics

2.1 General

(1) Design of structures using HPFRCC shall be carried out as follows. First the required performance of the structure, the structural planning and structural details are determined. Then it is examined if the required performance is satisfied throughout the design service life.

(2) Design of structure using HPFRCC shall take into account the rational structural combination with reinforcing steel bar/frames, normal reinforced concrete structural elements and precast elements, and shall examine construction methods such as placement and spraying in consideration of construction performance, maintainability and economical efficiency.

[Commentary] Because the design process of HPFRCC structure is similar to that of normal concrete structure, design principle can be based on the Standard Specifications for Concrete Structures. This “Recommendations” document mainly deals with steel reinforced HPFRCC members and the existing reinforced concrete members covered with HPFRCC, excluding HPFRCC structure without reinforcement. Design of composite structures with steel members and various members should refer to the Standard Specifications for Concrete Structures.

2.2 Design service life

(1) Design service life of structure using HPFRCC shall be determined taking into account the service life required for the structure, maintenance methods, environmental conditions, changes in performance of the structure and economical efficiency.

[Commentary] When designing a structure using HPFRCC, the service life of the structure needs to be designed. The designed service life should be determined taking account of its in-service period, environmental conditions and degradation of structural performance with time. The in-service period of the structure may be determined with its intended purpose and economical efficiency. Using accelerated methods as shown in the document appendix II-7, Service lives of HPFRCC itself and reinforcing fiber should in principle be confirmed to be longer than that of the structure.

2.3 Principles of performance verification

(1) Performance verification of structure using HPFRCC shall in principle be executed by confirming the satisfaction of the required performance taking into account changes in the required performance during construction and its service life. When conditions in Chapter 9 are satisfied, effects of environment on the changes in the performance with time can be neglected.

(2) Performance verification of structure shall in principle be executed by confirming that the

HPFRCC structure or member with designed structural details– materials, shape and dimension etc.–, do not reach the limit states that can be set according to the performance requirements, status – under construction or in service – and type of the HPFRCC structure.

(3) Performance verification of structure shall in principle be executed by comparing the limit value of the appropriately specified verification indexes and response value.

[Commentary] (1) When safety, serviceability and recoverability performance of structures are verified, possible changes in the performance over time should in principle be taken into account, while deterioration of consisting materials during the service life of the structure need not be considered if the chapter 9 of this “Recommendations” document is fulfilled. It is necessary to assure the degree of safety by assuming accuracy of structure dimensions, accuracy of bar arrangement and variation of mechanical properties of materials.

(2) Based on the Standard Specifications for Concrete Structures, this “Recommendations” document in principle adopts a method by which the performance requirements for structures are clearly specified and limit states corresponding to each performance requirement are prescribed. When a structure or a part of a structure reach a limit state condition, serviceability decreases rapidly and may sometimes result in a failure. The structure becomes nonfunctional and the required performance is no longer fulfilled due to various failures. In this case, verification of the limit state can substitute for the performance verification of the structure. For a specific limit state, a limit value corresponding to the performance requirements may be given by selecting indexes representing the states of materials, members and structures. Response to the external loads is evaluated and verified whether the responses exceed the limit value. The limit value should be prescribed taking into account the reliability of analytical methods and models by which the response values are calculated.

(3) For a rational performance verification of structures, verification indexes that represent performance requirements as directly as possible should be employed to evaluate the limit values with respect to the response values. This “Recommendations” document refers to *the Standard Specifications for Concrete Structures* for performance requirements, limit states and verification indexes and an example is shown in Table 2.3.1.

Table 2.3.1 Performance requirements, limit states and verification indexes

Performance requirements	Performance	Limit state	Verification index	Actions considered
Safety	Fracture and collapse of structure or member	Sectional failure	Force	All actions at maximum
		Fatigue failure	Stress intensity, force	Cyclic action
		Structural stability	Deformation	All actions at maximum, accident
	Safety in use	Cursoriality	Acceleration, vibration, deformation	All actions at maximum, accident
		Disturbance	Falling of concrete (carbonation depth, chloride ion ingress)	Environmental action
Serviceability	Amenity	Cursoriality	Acceleration, vibration, deformation	Relatively frequent action
		Appearance	Crack width, stress intensity	Relatively frequent action
		Noise, vibration	Noise vibration level	Relatively frequent action
	Functionality	Water-tightness	Water permeability, crack width	Relatively frequent action
		Air-tightness	Air permeability, crack width	Relatively frequent action
		Shielding	Mass-energy loss	Relatively frequent action
		Damage	Force, deformation	Changes, accident
Recoverability	Recoverability	Damage	Deformation, strain	Accident

2.4 Safety factors

(1) Safety factors shall be determined properly to take into account the precision of given material properties, difference in properties between material test specimens and the actual structure, reliability of design formulas and importance of the structure. Available safety factor values can be found in the Standard Specifications for Concrete Structures – *Structural Performance Verification*, section 2.6 “Safety factors” and in *Materials and Construction*, section 1.4 “Safety factors”.

Chapter 3 Material Properties for Design

3.1 General

(1) This chapter deals with material properties of HPFRCC particularly required as input for structural design. The material properties data on concrete, reinforcing steel and prestressing steels shall be based on Chapter 3 “Material Properties for Design” of the Standard Specifications for Concrete Structures –*Structural Performance Verification*.

(2) According to the performance verification needs, the quality of HPFRCC is expressed in terms of its compressive and tensile strength and other strength characteristics, deformation characteristics such as Young’s modulus and tensile strain capacity, and material properties such as thermal characteristics, durability and water-tightness. With regard to strength and deformation characteristics, the effects of reinforcing fiber shall be considered, as well as the impact of loading rate if necessary.

(3) The characteristic value of a material property shall be set in a way that ensures most test data would not fall below it, considering the variation of test data.

(4) The design value of a material property is obtained by dividing characteristic value of material property by material factor γ_m .

[Commentary] (1) Because the properties of concrete, reinforcing steel and prestressing steels used for structures (structural members) with HPFRCC are equivalent to those used for conventional concrete structures, instead of providing new provisions, Chapter 3 “Material Properties for Design” of the Standard Specifications for Concrete Structures –*Structural Performance Verification* should be referenced.

(2) Strength and deformation characteristics of HPFRCC largely depend on the combination of matrix and reinforcing fiber. Thus the HPFRCC used for structures or structural members should ensure adequate performance taking account of the intended purposes, environmental factors, service life, construction conditions and other factors.

The material properties presented in this chapter can be used when studying the limit state under static loading or ordinary dynamic loading. Where it is necessary to consider the effect of strain rate as in the impact loading, highly credible values such as those obtained in reliable experiments should be used.

(3) The characteristic value of each material property can be given by Eq. 3.1.1,

$$C_k \leq C_{km} - k\sigma \quad (3.1.1)$$

where, C_k : characteristic value, C_{km} : average of test data, σ is standard deviation of test data and k : a coefficient.

The coefficient k is determined by the probability of a test data falling below the characteristics value and the distribution curve of the test data. Assuming that the probability of a test value falling below the characteristics value is 5% and that the test data are normally distributed,

coefficient k is given as 1.64.

3.2 Strength and strain

3.2.1 Characteristic values

(1) In principle, the characteristic values of the strength and strain capacity of HPFRCC shall be determined through testing at the age of 28 days. However, they may be determined through tests at a different age that is considered appropriate in the light of such conditions as the intended purpose of the structure, timing of applying principal loads and construction program.

(2) For verification of ultimate limit state, material factor of HPFRCC γ_c is given as 1.3 ($f'_{ck} \leq 80$ N/mm²). It can be set at 1.0 when studying the serviceability limit state.

[Commentary] (2) In the Standard Specifications for Concrete Structures, γ_c is described as a material factor that is mainly designed to take into account the construction-related discrepancies between test specimens and actual concrete in the structure as well as the changes with time and the level of effect by sustained loading.

The discrepancies between test specimens and actual concrete in the structure, which are mainly induced during the construction process, are caused by such factors as a difference in temperature histories due to hydration heat, which depends on the size of member section, and a possible manufacturing defect, which may be produced by material anomalies or the construction quality levels. The former factor, the difference in the temperature histories due to hydration heat between the materials used in test specimens and actual member is small because HPFRCC members are generally thinner than conventional concrete members. Thus, it is assumed that the temperature histories due to hydration heat have insignificant impacts on material properties. Likewise, the latter factor, possible material anomalies, has insignificant impacts because HPFRCC does not require control of the surface moisture percentage of aggregates like ordinary concrete as it uses aggregates in the absolutely dry condition, and thus, any changes in unit water content are solely caused during weighing.

With regard to changes with time, it should be confirmed that the shrinkage cracking resistance and compressive creep property do not deviate substantially from those of ordinary concrete based on experiments or reliable existing data. In doing so, the material factor of HPFRCC can be made equivalent to that of ordinary concrete, in addition to the consideration of construction-caused influences described before. The shrinkage cracking resistance can be confirmed by drawing a comparison against that of ordinary concrete, according to JIS A 1151 or by equivalent experiments. Compressive creep can be verified, for example, by applying loads at the age of 28 days to confirm whether the creep coefficient does not exceed 1.5, as prescribed in the Standard Specifications for Concrete Structures –*Structural Performance Verification*. Tensile creep should in principle be confirmed whether there is no tensile creep failure at the characteristic value of tensile yield strength as specified in appendix II-9.

3.2.2 Tensile yield strength

The characteristic value of tensile yield strength of HPFRCC f_{tyk} shall be determined based on the stress-strain relationship immediately after first cracking obtained in the testing method 2.

[Commentary] In principle, the characteristic value of tensile yield strength f_{tyk} should be determined based on the results of the tests that are performed in the uniaxial direct tensile test described in the testing method 2 of this “Recommendations” document and Fig. 3.2.1. The definition of tensile yield strength is shown in Fig. 3.2.2. Size effect of tensile yield strength through testing method 2 was small when the thickness ranged from 13 to 50 mm (appendix II-8). An example of tensile yield strength of HPFRCC with a mix proportion and fiber as specified in Table 3.2.1 and Table 3.2.2 is shown in Table 3.2.3 and Fig. 3.2.3 with a statistics example of f_{tyk} obtained from the real constructions of total 49 batches.

Table 3.2.1 HPFRCC mix proportion example

W/ (C+FA) (%)	Unit water (kg/m ³)	S/ (C+FA) (%)	Fiber fraction (%)
42.2	350	70	2.0

Table 3.2.2 Properties of PVA fiber

Type	Diameter d_f (mm)	Length L_f (mm)	Elastic modulus E_f (N/mm ²)	Tensile strength (N/mm ²)
PVA	0.040	12	40600	1690

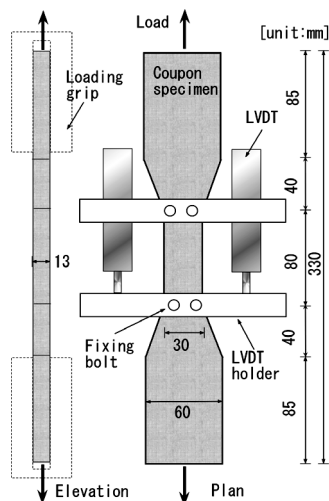


Fig. 3.2.1 Unconfined tensile test

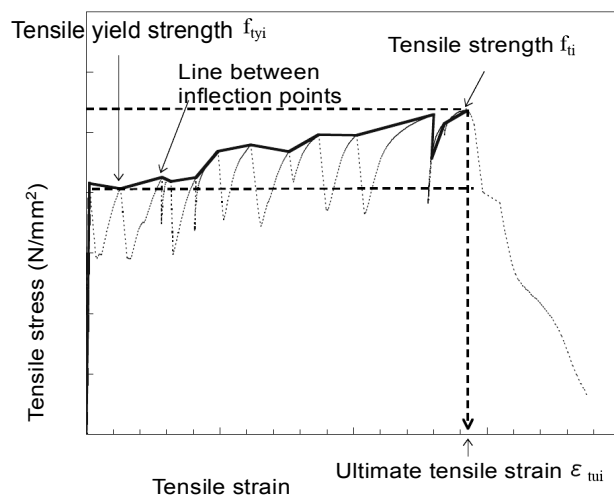


Fig. 3.2.2 Definition of tensile yield strength and tensile yield strain

Table 3.2.3 Statistics of tensile yield strength

Statistical parameter	Tensile yield strength
Average (N/mm ²)	3.27
Standard deviation (N/mm ²)	0.17
Variation coefficient (%)	5.23

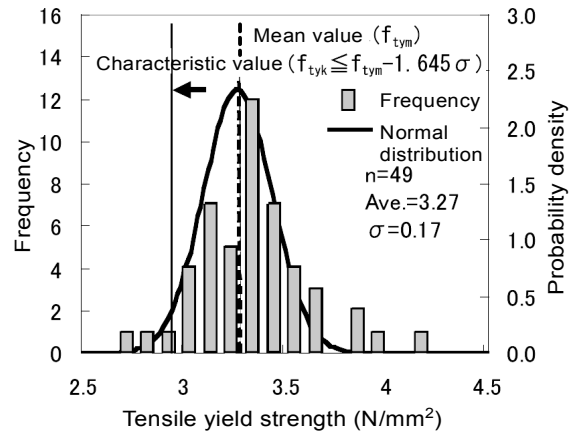


Fig. 3.2.3 Statistics of tensile yield strength

3.2.3 Tensile strength

The characteristic value of tensile strength of HPFRCC f_{tk} shall be determined based on the tensile strength values obtained with the testing method 2.

[Commentary] The characteristic value of tensile strength f_{tk} is defined as the maximum stress in the tensile stress-strain curve obtained with the uniaxial tensile test. In principle, the tensile tests should be performed by testing method 2 “Testing method of uniaxial direct tensile strength” specified in this “Recommendations” document.

An example of tensile strength of HPFRCC with the mix proportion and fiber as specified in Table 3.2.1 and Table 3.2.2 is shown in Table 3.2.4 and Fig. 3.2.4 with a statistics example of f_{ty} obtained from the real constructions of total 49 batches.

Table 3.2.4 Statistics of tensile strength

Statistical parameter	Tensile strength
Average (N/mm ²)	5.02
Standard deviation (N/mm ²)	0.37
Variation coefficient (%)	6.27

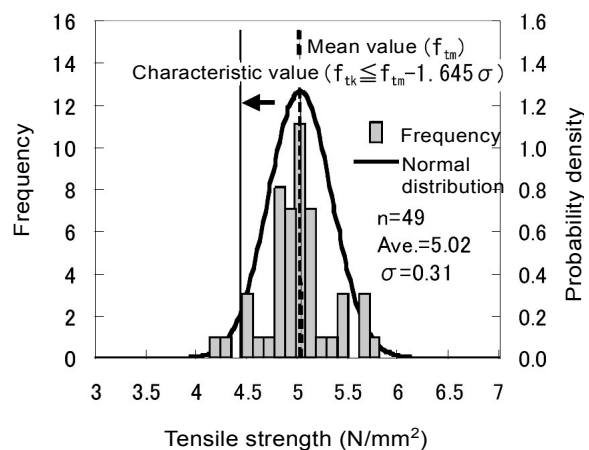


Fig. 3.2.4 Statistics of tensile strength

3.2.4 Ultimate tensile strain

The characteristic value of ultimate tensile strain of HPFRCC ε_{tuk} shall be determined based on the stress-strain relation obtained from testing method 2.

[Commentary] The characteristic value of ultimate tensile strain ε_{tuk} should in principle be obtained with testing method 2 “Testing method of uniaxial direct tensile strength” described in this “Recommendations” document. The definition of ultimate tensile strain in terms of tensile stress-strain curve is shown in Fig. 3.2.2. Statistic example of ε_{tuk} is shown in Table 3.2.5 and Fig. 3.2.5.

Table 3.2.5 Statistics of ultimate tensile strain

Statistical parameter	Ultimate tensile strain
Average (%)	5.08
Standard deviation (%)	0.83
Variation coefficient (%)	16.43

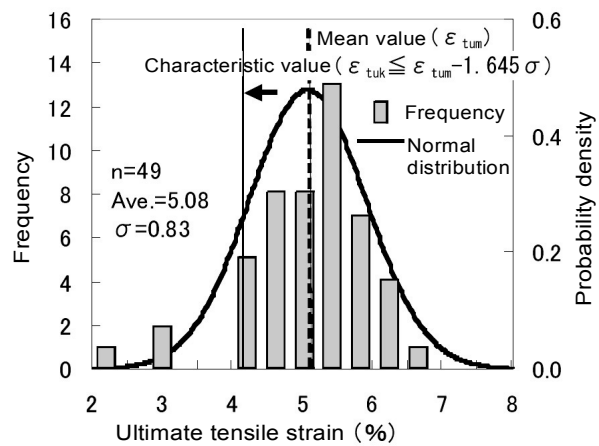


Fig. 3.2.5 Statistical values of ultimate tensile strain

3.2.5 Compressive strength

Characteristic value of compressive strength of HPFRCC f'_{ck} shall be determined based on JIS A 1108 “Method of test for compressive strength of concrete”.

[Commentary] For the compressive test on HPFRCC, the specimens according to the testing method 1- *Preparation of specimens for strength test* in this “Recommendations” document should be prepared and testing be performed according to JIS A 1108 “Method of test for compressive strength of concrete”. In principle, the tests should be performed using cylinder specimens of 100mm in diameter and 200mm in height. However, in the case of HPFRCC that does not contain any coarse aggregates, cylinder specimens of 50mm in diameter and 100mm in height may be used instead.

Described below is an example of compressive strength of HPFRCC with the mix proportions shown in Table 3.2.1 and the fiber shown in Table 3.2.2. Table 3.2.6 shows the statistics of

compressive strength, which were obtained by examining a total of 49 batches used in an actual construction work. Fig. 3.2.6 is a control chart of mean values. The variation coefficient of compressive strength is approximately 6%, which is not very different from that of ordinary concrete. A comparison between 100mm and 50mm diameter specimens shows that the averaged compressive strength of the former is lower than that of the latter approximately by 6%. If necessary, a correlation between them may be determined beforehand and commuted accordingly.

Table 3.2.6 Statistics of compressive strength values

Statistical parameter	Dimensions of specimen	
	Diameter: 100, Height: 200 (mm)	Diameter: 50, Height: 100 (mm)
Average (N/mm ²)	34.3	36.8
Standard deviation (N/mm ²)	2.1	2.3
Variation coefficient	6.06	6.34

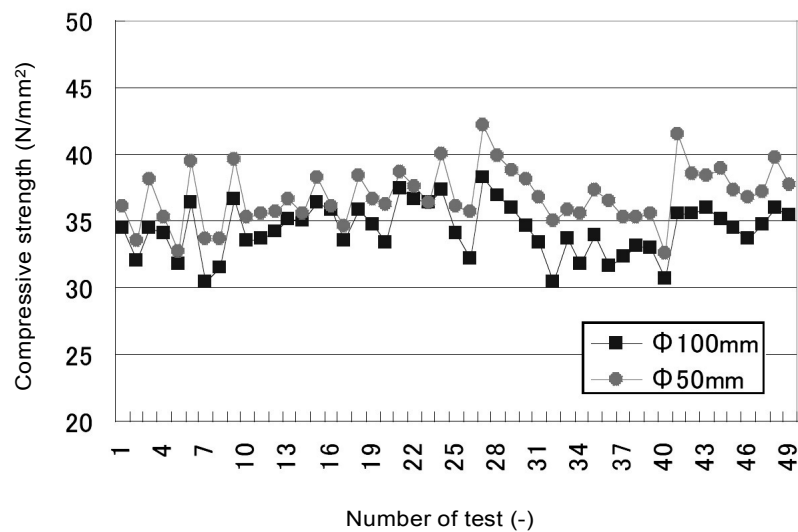


Fig. 3.2.6 Compressive strength control chart

3.3 Stress-strain curves

3.3.1 Tensile stress-strain curve

- (1) Tensile stress-strain curve of HPFRCC shall be determined through an appropriate test method. According to the limit state in question, an appropriate shape can be assumed based on the reliable past data.
- (2) The tensile stress-strain curve shown in Fig. 3.3.1 can be used when studying the ultimate limit state of section fracture for members subjected to a bending moment or a bending moment and axial forces.
- (3) The tensile stress-strain curve shown in Fig. 3.3.1 can be used for serviceability verification.

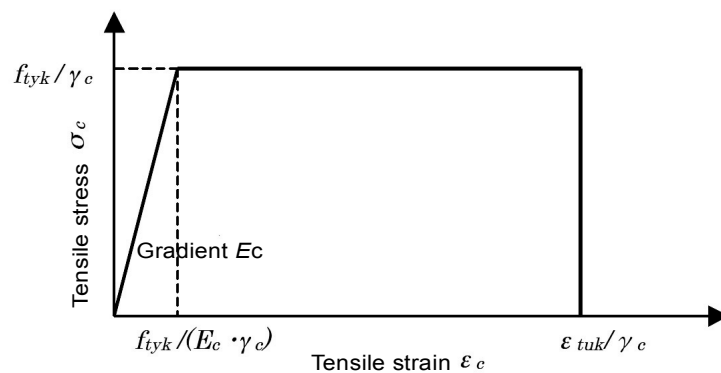


Fig. 3.3.1 Tensile stress-strain relationship

[Commentary] When representing the tensile stress-strain curve of HPFRCC with a simple approximation, it was possible to achieve the same level of conformity as that for ordinary RC members through the use of a perfect elastoplastic model that has the tensile yield strength at the peak as illustrated by the broken line in Fig. 3.3.1. For this reason, this “Recommendations” document adopts a perfect elastoplastic model that uses the characteristic values of tensile yield strength divided by the material safety factor, as denoted by a solid line in the figure.

The ultimate strain of HPFRCC is normally greater than the yield strain of the reinforcing bar and the strain of the tensile steel bar reaches yield strain before HPFRCC reaches its ultimate strain. Thus the effect of the ultimate strain value of HPFRCC on the cross-sectional strength is estimated negligible. In the analytical result mentioned above, a model that assumes the tensile yield strength can be maintained even if it exceeds the ultimate strain of 1.3 percent (0.0013) obtained from a material test gives a HPFRCC’s tensile strain of 1.7 percent (0.017) showing good agreement with that of experiments. Therefore, the characteristic value of ultimate tensile strain as shown in 3.2.4 of this “Recommendations” document can be regarded as the ultimate strain. When the design cross-sectional strength is underestimated in analysis, the tensile stress-strain relation should be appropriately reevaluated. Also the failure mode needs to be confirmed with a model that appropriately reflects the stress-strain relation of HPFRCC.

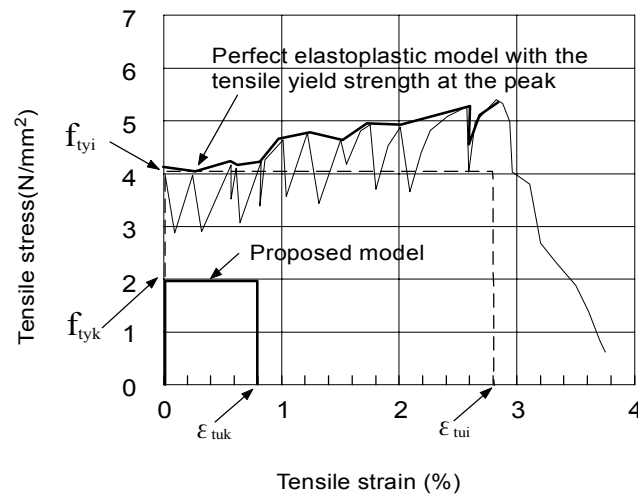


Fig. 3.3.1 Comparison between experimental results and the design stress-strain relationship

3.3.2 Compressive stress-strain curve

(1) The compressive stress-strain curve of HPFRCC shall in principle be determined through an appropriate test. An appropriate shape of compressive stress-strain curve can be assumed according to the nature of the ultimate state based on the reliable past data.

(2) The compressive stress-strain curve like the one shown in Fig. 3.3.2 may be used when studying the ultimate limit state of section failure for the members subjected to a bending moment or a bending moment and axial compressive forces. ε'_m and ε'_{cu} can be determined based on appropriate tests. The following stress-strain equation can be applied for the initial curved zone.

$$\sigma'_c = 0.85 f'_{ck} / \gamma_c \times \varepsilon'_c / \varepsilon'_m \times (2 - \varepsilon'_c / \varepsilon'_m) \quad (3.3.1)$$

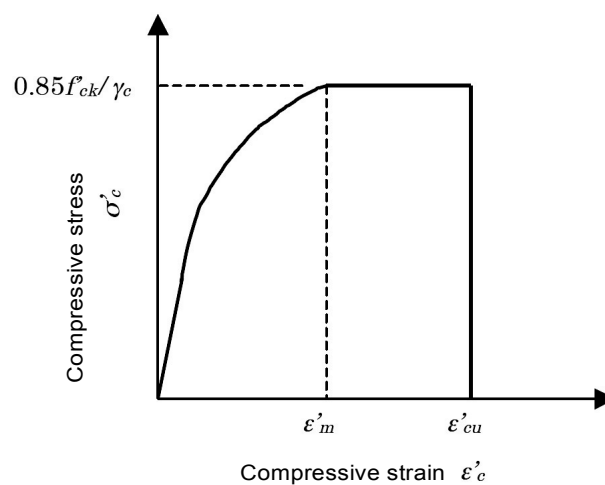


Fig. 3.3.2 Compressive stress-strain relationship

(3) The compressive stress-strain relationship can be regarded as linear when serviceability performance is verified. Young's modulus can be determined according to section 3.4.

(4) Evaluation of the compressive stress-strain relationship under biaxial or triaxial stresses shall take into account the effects of multi-axial stress conditions where necessary when verifying safety or serviceability performance. The material shall be assumed as linear-elastic for examination of the serviceability limit state, and Young's modulus and Poisson's ratio can be set at values specified in sections 3.4 and 3.5, respectively.

[Commentary] (2) An example of compressive stress-strain relationship, which is derived from the results of tests on cylinder specimens of 100 mm in diameter and 200 mm in height, is shown in Fig. 3.3.2. As shown in the figure, the strain value at the maximum load is 0.4% (0.004) approximately. In the compressive stress-strain relationship shown in Fig. 3.3.2, the strain ϵ'_m at the peak stress is greater than 0.002, i.e. that of ordinary concrete. This shows one of the characteristics of HPFRCC; the stress decreases slowly with increasing strain after the maximum load thanks to the confinement effect by fiber bridging.

To take into account these HPFRCC material characteristics in structural design, it is necessary to determine the stress-strain relation on the basis of flexural tests of HPFRCC. However, when appropriate test data are not available, ϵ'_m can be the strain at the maximum compressive stress, and ϵ'_{cu} can be set equal to ϵ'_m .

(4) ϵ'_m and ϵ'_{cu} in the compressive stress-strain relation of HPFRCC are subjected to the surrounding restraint as in normal concrete and hence should be determined taking into account the restraint at working positions.

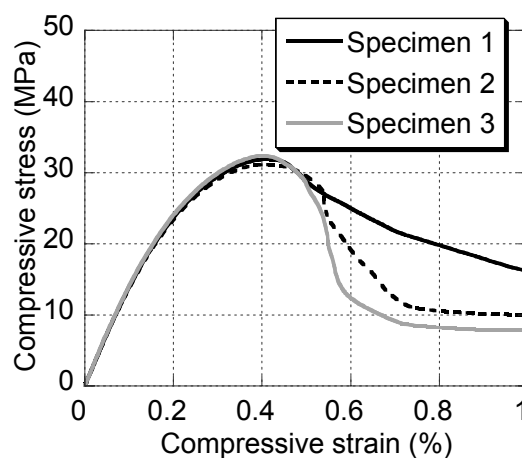


Fig. 3.3.2 Example of compressive stress-strain curve

3.4 Young's modulus

In principle, Young's modulus of HPFRCC shall be derived from JIS A 1149 "Method of Test for static modulus of elasticity of concrete".

[Commentary] Young's modulus of HPFRCC can be obtained by adopting the testing method used for ordinary concrete. The Young's modulus thus obtained takes a smaller value, i.e. between 1/2 and 2/3 or so of that for ordinary concrete. Fig. 3.4.1 shows an example of relationship between Young's modulus and compressive strength expressed in measured values.

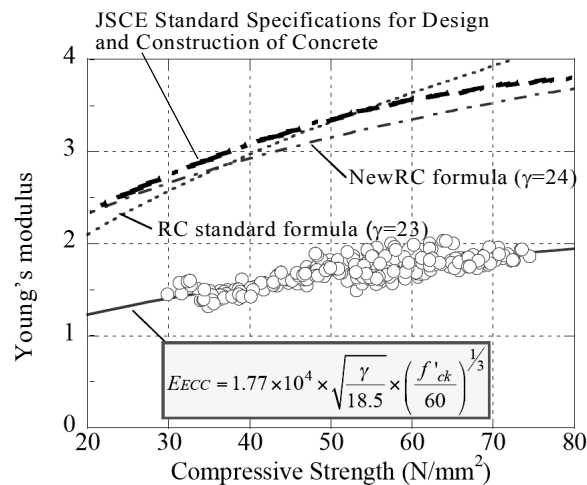


Fig. 3.4.1 Example of determination of Young's modulus

3.5 Poisson's ratio

Poisson's ratio of HPFRCC shall be determined based on experiments or on existing data.

[Commentary] Fig. 3.5.1 is an example of the measured Poisson's ratio of HPFRCC. As shown in the figure, the Poisson's ratio of HPFRCC is slightly higher than that of ordinary concrete, yielding an average value of 0.226. Values listed in the *List of Characteristics Values for HPFRCC Products* of appendix I-1 can also be used.

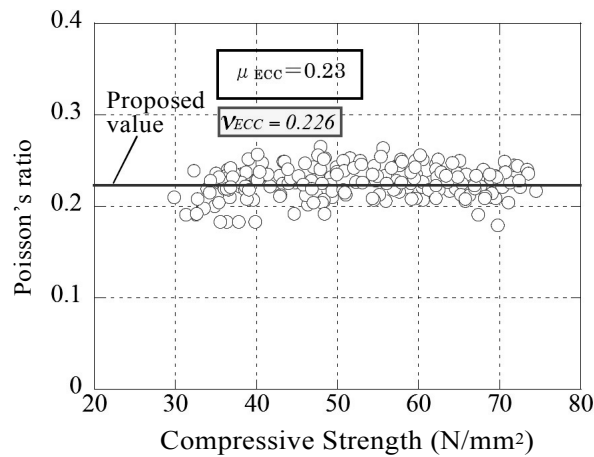


Fig. 3.5.1 Example of determination of Poisson's ratio

3.6 Thermal characteristics

In principle, the thermal characteristics of HPFRCC shall be determined based on experiments or on existing data.

[Commentary] The thermal characteristics of HPFRCC change with such factors as moisture conditions or temperature, and there is no sufficient accumulation of data available. Thus, they should be determined based on the results of experiments in principle.

Table 3.6.1 shows an example of thermal characteristics of HPFRCC specimen that was made with mix proportions shown in Table 3.2.1 and fibers shown in Table 3.2.2, and subjected to the 20°C sealed curing until the age of 28 days. Those of the normal concrete quoted after the Standard Specifications for Concrete Structures – *Materials and Construction* are also shown in this table. The values in the *List of Characteristic values for HPFRCC Products* of appendix I-1 can also be used.

Table 3.6.1 Example of thermal characteristics

Material	Thermal conductivity (W/m K)	Specific heat (J/g K)
HPFRCC	0.463	1.44
Normal concrete	2.6 - 2.8	1.0 - 1.26

3.7 Shrinkage

In principle, shrinkage of HPFRCC shall be determined based on experimental results, taking into account the material properties, mix proportions, curing conditions, humidity around the structure, and sectional profiles and dimensions of the members.

[Commentary] Shrinkage of HPFRCC should be determined through experiments according to JIS A 6202 appendix or JIS A 1129, because there are large variations depending on materials used and mix proportions. Unit water of HPFRCC tends to be greater than that of normal concrete so that appropriate actions should be taken to control shrinkage in the same level as that of the normal concrete. Application of expansive additives or shrinkage reducing agents can effectively reduce drying shrinkage, and the drying shrinkage level of HPFRCC can be reduced to that of ordinary concrete. Fig. 3.7.1 shows an example of shrinkage behavior of HPFRCC using expansive additives and shrinkage reducing agents. Crack dispersibility and bridging effect of reinforcing fiber may control crack width if any.

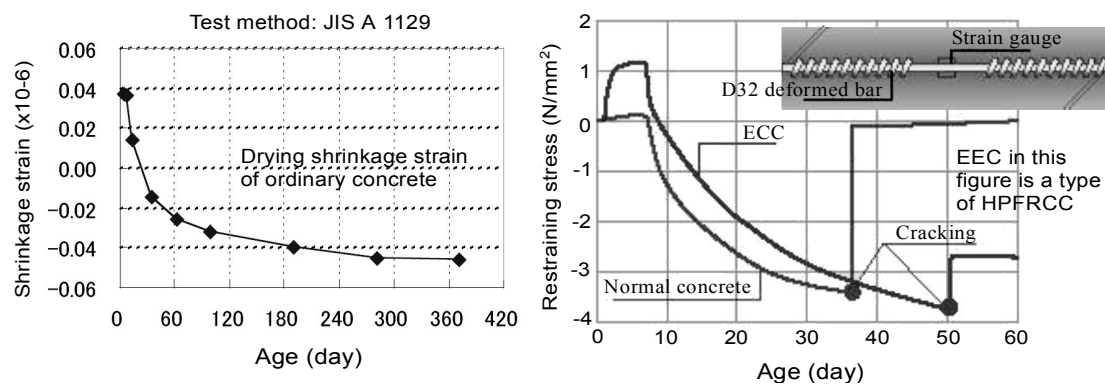


Fig. 3.7.1 Example of drying shrinkage behavior of HPFRCC

3.8 Creep

(1) Tensile creep strain of HPFRCC shall be determined in the basis of experiments or existing data.

(2) In general, the compressive creep strain of HPFRCC can be obtained by the following equation, assuming it is proportional to the stress at work:

$$\varepsilon'_{cc} = \varphi \sigma'_{cp} / E_{ct} \quad (3.8.1)$$

where,

ε'_{cc} : compressive creep strain of HPFRCC

φ : creep coefficient

σ'_{cp} : compressive stress at work

E_{ct} : Young's modulus at the age when loading is applied

[Commentary] (1) Because HPFRCC can be designed assuming a tensile contribution of HPFRCC member, the material may occasionally be subjected to permanent tensile loading conditions. Moreover, HPFRCC can maintain the tensile loading capacity after cracking. Hence creep of HPFRCC in tension should be verified with experiments reflecting appropriate working

conditions or with existing experimental data. It is of particular importance to confirm that the tensile creep limit exceed the characteristic value of the design tensile yield strength.

An experiment of tensile creep strain of HPFRCC with a high-strength PVA fiber (appendix II-9) may be referred to regarding the tensile creep strain.

(2) HPFRCC is susceptible to large creep strain because as compared with ordinary concrete it has a small amount of aggregates that effectively restrict creep deformation. However, owing to the low elastic modulus, HPFRCC may have a small creep coefficient, as in the case for lightweight concrete. Fig. 3.8.1 shows the creep coefficient obtained from cylinder specimens of 100mm in diameter and 200mm in height, which are subjected to a loading whose level is equivalent to one quarter of compressive strength at the age of 28 days. The environmental conditions of creep tests were 20°C and 60% RH. The figure also shows the calculation results for the creep coefficient of concrete under the same conditions, which were obtained using an estimate equation proposed in the literature. As shown in the figure, the creep coefficient of HPFRCC is approximately three quarters of that of ordinary concrete under the same level of compressive strength.

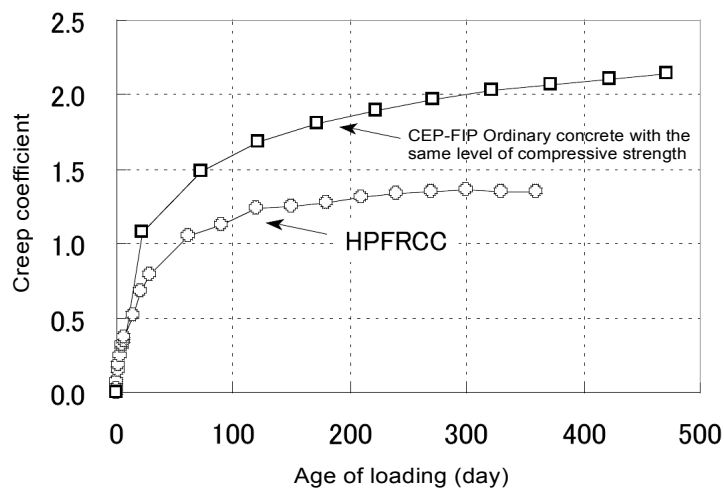


Fig. 3.8.1 Example of creep behavior of HPFRCC

3.9 Fatigue

(1) The characteristic value of HPFRCC's fatigue strength shall be determined from the results of fatigue strength tests that are performed in consideration for the exposed condition of the structure and other relevant conditions.

(2) In general, material factor of HPFRCC γ_c is set at 1.3 in the fatigue limit state.

(3) In general, the design compressive/flexural compressive fatigue strength of HPFRCC f_{rd} can be obtained by Equation (3.9.1), assuming it is a function of fatigue life N and permanent-load-induced stress σ_p . It shall be noted, however, that the fatigue strength shall be experimentally determined where HPFRCC is continuously or often saturated with water.

$$f_{rd} = 0.85f_d \left(1 - \sigma_p / f_d\right) (1 - \log N / 17) \quad (\text{N/mm}^2) \quad (3.9.1)$$

where, $N \leq 2 \times 10^6$, f_d : design compressive strength of HPFRCC, and material factor γ_c is given as 1.3 here.

(4) The design compressive/flexural compressive fatigue strength of HPFRCC f_{rd} shall be experimentally determined, assuming it is a function of fatigue life N and stress σ_p .

[Commentary] (3) Because compressive fatigue characteristics are known to be improved greatly by reinforcement with fiber, the values used in the design of ordinary concrete are also used here as a conservative design value for HPFRCC.

(4) Fig. 3.9.1 is presented as an example of flexural tensile fatigue strength of HPFRCC. As shown in the figure, a bilinear approximation can be adopted for HPFRCC's flexural tensile fatigue strength when the number of fatigue cycle N_u is logarithmically represented. This can be given by the following equations where S is the ratio of flexural tensile stress to the statistic flexural strength under fatigue loading. When S is 0.5 or lower, no fatigue failure occurs upon 2 million times of fatigue cycles.

$$S = 1.000 - 0.0098 \times \log(N_u) \quad 1 \leq N_u < 1 \times 10^4 \quad (3.9.1)$$

$$S = 1.595 - 0.0761 \times \log(N_u) \quad 1 \times 10^4 \leq N_u \leq 2 \times 10^6 \quad (3.9.2)$$

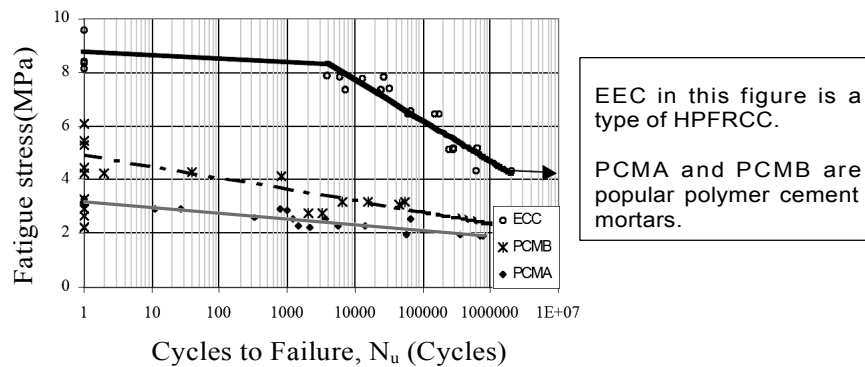


Fig. 3.9.1 Example of flexural fatigue test of HPFRCC

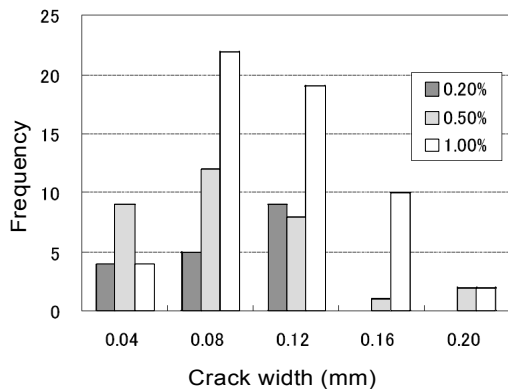
3.10 Maximum crack width

In principle, the maximum crack width of HPFRCC shall be determined according to the testing method 3 or existing data.

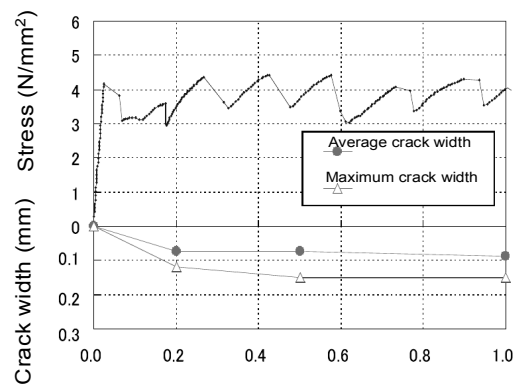
[Commentary] A maximum crack width that may occur at the ultimate standard tensile strain is defined as a maximum crack width of HPFRCC. Although HPFRCC develops numerous fine cracks when subjected to a large extent of tensile strain, it is its characteristics that each crack is not widened beyond a point that is detrimental to the maintaining the required functionality. Crack width measurement was carried out according to the testing method 3 “Testing method for crack width of HPFRCC – Average and maximum crack widths” of this “Recommendations” document with an HPFRCC manufactured according to the mix proportion and the fiber specification as described in Table 3.2.1 and Table 3.2.2. Loads were applied until the tensile strain reached 0.2, 0.5 and 1.0% when the crack widths were measured as the load was maintained. The results are shown in Fig. 3.10.1 where the crack width is distributed over a wide range up to 0.2 mm. Fig. 3.10.2 shows the crack development on specimen surfaces, and Fig. 3.10.3 is an enlarged view of these surface cracks. Table 3.10.1 is the calculation results for the statistics of crack width, which are obtained based on the testing method 4.

The maximum crack width can be controlled by modifying the type and shape of the reinforcing fiber and water-cement ratio of matrix. An example of the control is shown in Fig. 3.10.4, where the residual crack width distribution of HPFRCCs with PVA fiber and polyethylene fiber are compared. The polyethylene fiber was 0.038 mm in diameter and 19 mm in length, and was mixed with a cement paste with water-cement ratio of 27%. It is seen that the HPFRCC with the polyethylene fiber exhibited larger crack width than that with PVA fiber. This may be attributed to smaller bond strength between the polyethylene fiber and matrix than that of PVA fiber. A

smaller bond strength between matrix and polyethylene fiber than that of PVA fiber has significant influence on this difference. However, when a smaller fiber diameter of 0.01 mm, for instance, is selected for the polyethylene fiber, crack width can be distributed in a equivalent range as narrow as that of PVA fiber shown in Fig. 3.10.1. The bond strength is of course affected by the mix proportion of the matrix. It tends to be lower with an increase in water-cement ratio, thereby the maximum crack width control is possible not only by the type and shape of reinforcing fiber but also by mix proportion of matrix.



(a) Crack width distribution



(b) Relationship between crack width and tensile strain

Fig. 3.10.1 Example of crack width distribution measurement

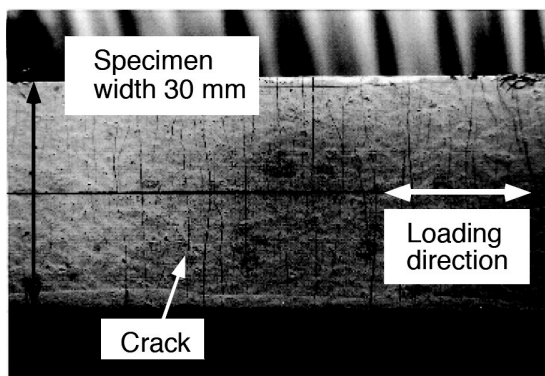


Fig. 3.10.2 Development of cracks

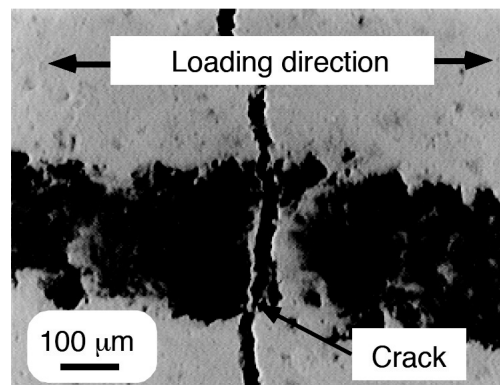


Fig. 3.10.3 Example of crack width measurement

Table 3.10.1 Statistics of crack width

Crack width statistical parameter	Strain 0.2 %	Strain 0.5 %	Strain 1.0 %
Average crack width (mm)	0.073	0.088	0.088
Variation coefficient (%)	39.7	62.7	42.4
Maximum crack width (mm)	0.12	0.15	0.15

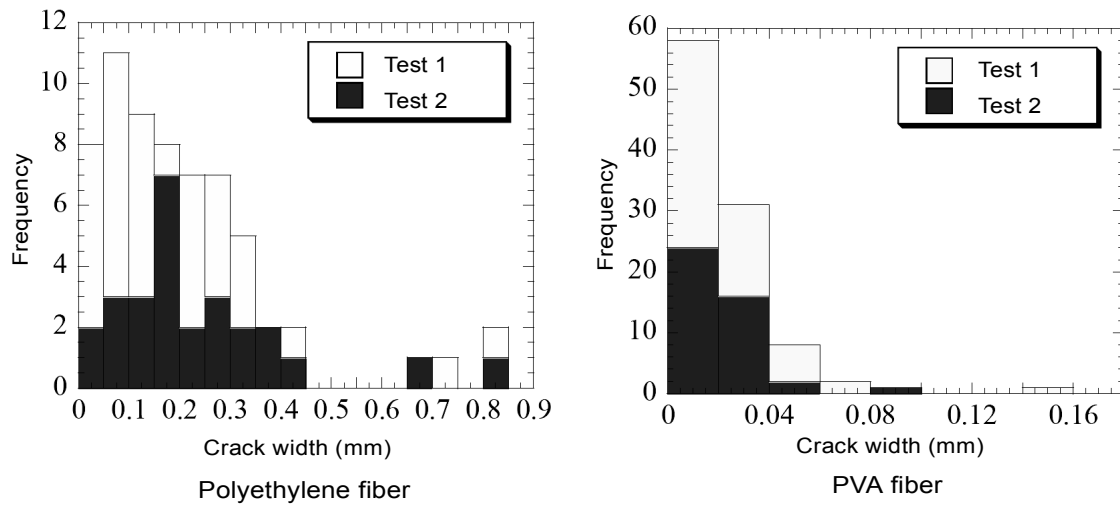


Fig. 3.10.4 Example of crack width distributions of HPFRCC

Chapter 4 Loads

4.1 General

- (1) In principle, refer to Chapter 4 “Load” of Standard Specifications for Concrete Structures - “Structural Performance Verification”.
- (2) Unit weight of HPFRCC necessary for calculating the dead load shall be based on measured values of products obtained with specified manufacturing method.

[Commentary] (1) Concept of load is not different from that of normal concrete and Chapter 4 “Load” of Standard Specifications for Concrete Structures - *Structural Performance Verification* should be referred to except for items that are dealt with in this chapter.

(2) Unit weight of HPFRCC may vary according to the materials combination and manufacturing method, hence actual measurement is recommended for the dead load estimation. For instance, the unit weight of ECC, one type of HPFRCC, with PVA fiber content of 2 vol. % ranges from 17 to 19 kN/m³

Chapter 5 Structural Analysis

5.1 General

In principle, refer to Chapter 5 “Structural analysis” of Standard Specifications for Concrete Structures - *Structural Performance Verification*.

5.2 Response value calculation for safety verification

(1) Bending moment at supports or joints in continuous beam, continuous slab and rigid-frame structure can be redistributed on the basis of linear analysis. The distribution factor shall be evaluated on the basis of experiments or reliable numerical analysis.

(2) For seismic effects, refer to Chapter 3 “Method of seismic performance verification” of Standard Specifications for Concrete Structures - *Seismic Performance Verification*.

(3) Response value calculation for safety verification other than the above, refer in principle to Section 5.2 “Calculation of structural response for examination of ultimate limit state” of Standard Specifications for Concrete Structures - *Structural Performance Verification*.

5.3 Response value calculation for serviceability verification

(1) Response value calculation for serviceability verification shall in principle be based on linear analysis. Rigidity for the estimation of member forces can be estimated assuming that the entire cross section is effective. While under temperature variations or shrinkage, member forces can be estimated taking into account a reduction of rigidity due to cracking for structural members with possible crack formation at the serviceability limit state.

(2) Displacement and deformation of structures using HPFRCC shall in principle be analyzed taking into account the reduction of rigidity due to cracking and possible creep and shrinkage during the design life of structures.

[Commentary] (1) HPFRCC shows a sufficiently elastic deformation at the serviceability limit state hence the application of linear analysis can be in principle adopted as a practical approach.

When estimating member forces induced by temperature changes and shrinkage, it is appropriate to include the stiffness reduction of a member due to cracking at the serviceability limit state because it reflects the behavior of real structures and results in avoiding excessive reinforcement. For calculating the stiffness reduction, the shape of the cross section, reinforcing bar arrangement, creep and shrinkage of HPFRCC can be taken into account.

(2) For estimation of deformation in structures, the possible stiffness reduction due to cracking and creep of HPFRCC as shown in section 7.2 of this “Recommendations” document should be in principle taken into account.

Chapter 6 Safety Verification of Structures

6.1 General

In principle, follow Chapter 6 “Verification of Structural Safety” of Standard Specifications for Concrete Structures –*Structural Performance Verification*.

6.2 Examination of safety against bending moment and axial forces

6.2.1 Design capacity of member cross section

(1) For a member subjected to axial compressive force, the upper limit for axial compressive capacity N'_{oud} shall be calculated by Eq.(6.2.1) .

$$N'_{oud} = (k_1 f'_{cd} A_c + f'_{yd} A_{st}) / \gamma_b \quad (6.2.1)$$

where A_c : cross-sectional area of HPFRCC,

f'_{cd} : design compressive strength of HPFRCC

A_{st} : total cross-sectional area of longitudinal reinforcing steel

f'_{yd} : design compressive yield strength of longitudinal reinforcing steel

k_1 : strength reduction factor ($1 - 0.003 f'_{ck} \leq 0.85$ with $f'_{ck} \leq 80 \text{ N/mm}^2$)

f'_{ck} : characteristic value of compressive strength of HPFRCC (N/mm^2)

γ_b : member factor; which may generally be taken as 1.3.

(2) Assumptions set out in (i), (ii) and (iii) below shall be followed when calculating the design capacity of a member subjected to bending moment and axial force, with regard to either the member's cross-section or unit width depending on the direction of the stress resultant. In such a case, the member factor γ_b may generally be taken as 1.1.

(i) Fiber strain is proportional to the distance from the neutral axis.

(ii) Stress-strain curve of HPFRCC follows that given in section 3.3 when the design tensile yield strength f'_{tyd} is greater than 1.5 N/mm^2 . Tensile stress of HPFRCC is neglected if f'_{tyd} is smaller than 1.5 N/mm^2 .

(iii) Stress-strain curve of steel reinforcement follows that given in section 3.3.3 “Stress-strain relationship” of Standard Specifications for Concrete Structures –*Structural Performance Verification*.

[Commentary] (1) Where a member subjected to axial compressive force has a small M_d/N'_d , the load-bearing capacity is considerably decreased by a slight increase in bending moment, due to the resulting increase in eccentricity, which might be caused during the construction process for example. To exclude such cases, the design compressive capacity is given an upper limit, where the member factor is taken as 1.3.

(2) HPFRCC is a highly ductile material exhibiting pseudo-strain hardening characteristics under uniaxial tensile stress and can bear part of the tensile forces in a stable manner. The contribution of tensile stress of HPFRCC to the capacity of member cross section is taken account in the verification of safety. However, when the tensile yield strength of HPFRCC is small, the

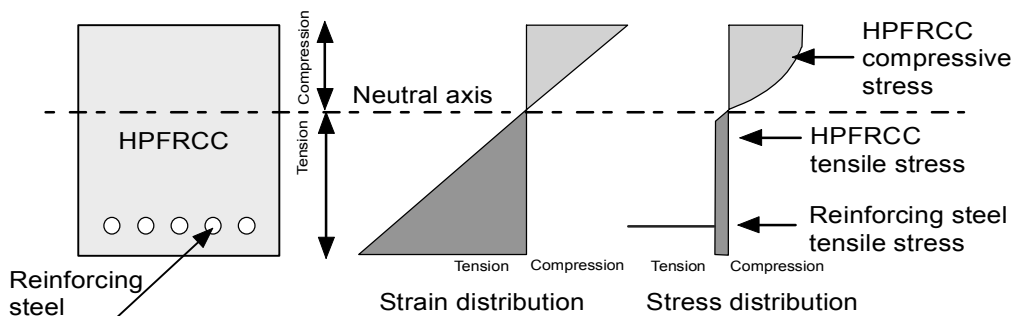


Fig. 6.2.1 Schematic representations of strain and stress distributions

contribution to the capacity of member cross section is found to be small by experiment. Thus, tensile stress of HPFRCC can be considered only in the case that the design tensile yield strength f_{tyd} is greater than 1.5 N/mm^2 . The strain and stress distributions are schematically represented by Fig. 6.2.1.

Derived from Standard Specifications, the bending capacity calculation method described here has already been verified. Thus, member coefficient ϕ_b is taken as 1.1 as prescribed in the Standard Specifications.

Figure 6.2.3 shows the results of a verification study on the bending capacity calculation method, applying HPFRCC to the 70-mm tensile-side portion of the member with a total thickness of 180mm, tied with truss reinforcements (Fig. 6.2.2). It has been confirmed that the test results (“ECC-measured” in Fig. 6.2.3) can be evaluated by analysis based on assumptions (i), (ii) and (iii) (“HPFRCC-analysis” in the same figure). The same figure also shows the results of a reinforced concrete structure made solely of ordinary concrete, i.e. without HPFRCC (“RC-measured” in the same figure). It shows that the HPFRCC specimens exert greater bending capacity thereby confirming the reinforcement effects of HPFRCC.

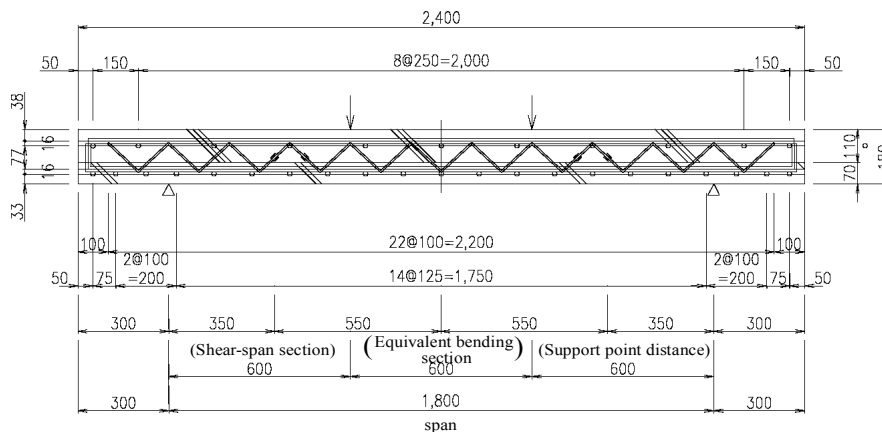


Fig. 6.2.2 Outline of specimen for bending test

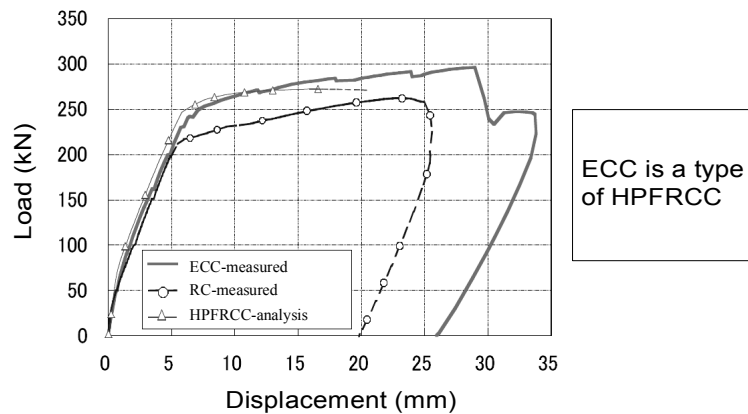


Fig. 6.2.3 Load-displacement curve

6.2.2 Structural details

In principle, structural details shall be determined based on section 6.2.2 “Structural details” of Standard Specifications for Concrete Structures –*Structural Performance Verification*.

[Commentary] When the tension reinforcement ratio becomes extremely small in a reinforced concrete member, the yielding load becomes smaller than the cracking load, and steel bars may yield or fracture immediately after cracking and the bending member shows brittle failure mode. Only one crack may occur and it may show a failure mode like unreinforced concrete. This requires the tension reinforcement ratio of a rectangular member, where flexural moment is dominant, should be larger than 0.2 percent as specified in Standard Specifications for Concrete Structures –*Structural Performance Verification*. HPFRCC on the other hand is a highly ductile material showing pseudo strain-hardening characteristics and can bear tensile stress in a stable manner. Experimental results showed that cracking did not result in a brittle failure even though tension reinforcement ratio is smaller than 0.2 percent. However, this “Recommendations” document follows Standard Specifications for Concrete Structures –*Structural Performance Verification* because sufficient data is not yet available.

6.3 Examination of safety against shear forces

6.3.1 General

Except otherwise specified in this Chapter, follow section 6.3 “Shear” of Standard Specifications for Concrete Structures—*Structural Performance Verification*.

6.3.2 Design shear force of linear members

Follow section 6.3.2 “Design shear force of linear members” of Standard Specifications for Concrete Structures –*Structural Performance Verification*.

6.3.3 Design shear capacity of linear members

The design shear capacity of a linear member consisting solely of HPFRCC and reinforcing steels V_{yd} may be obtained by Equation (6.3.1) below.

$$V_{yd} = V_{cd} + V_{sd} + V_{fd} + V_{ped} \quad (6.3.1)$$

where V_{cd} : design shear capacity of a linear member without any shear reinforcing steels, excluding the strength exerted by reinforcing fiber, which is given by Equation (6.3.2) below.

$$V_{cd} = \beta_d \cdot \beta_p \cdot \beta_n \cdot f_{vcd} \cdot b_w \cdot d / \gamma_b \quad (6.3.2)$$

$$f_{vcd} = 0.7 \times 0.20 \sqrt[3]{f'_{cd}} \quad (\text{N/mm}^2), \text{ where } f_{vcd} \leq 0.50 (\text{N/mm}^2) \quad (6.3.3)$$

$$\beta_d = \sqrt[4]{1/d} \quad (d : \text{m}) \quad \text{when } \beta_d > 1.5, \beta_d \text{ is taken as } 1.5.$$

$$\beta_p = \sqrt[3]{100 p_w} \quad \text{when } \beta_p > 1.5, \beta_p \text{ is taken as } 1.5.$$

$$\beta_n = 1 + M_0 / M_d \quad (N'_d \geq 0) \quad \text{when } \beta_n > 2, \beta_n \text{ is taken as } 2.$$

$$\beta_n = 1 + 2M_0 / M_d \quad (N'_d < 0) \quad \text{when } \beta_n < 0, \beta_n \text{ is taken as } 0.$$

N'_d : design axial compressive force

M_d : design bending moment

M_0 : bending moment necessary to cancel stress due to axial force at extreme tension fiber corresponding to design bending moment M_d .

b_w : width of member

d : effective depth

$$p_w = A_s / (b_w \cdot d)$$

A_s : cross-sectional area of tension reinforcement

f'_{cd} : design compressive strength of concrete (N/mm²)

γ_b : 1.3 in general

V_{sd} : design shear capacity of shear reinforcement, given by Equation (6.3.4) below.

$$V_s = [A_w f_{wyd} (\sin \alpha_s + \cos \alpha_s) / s_s] z / \gamma_b \quad (6.3.4)$$

A_w : total cross-sectional area of the shear reinforcing steel placed at spacing s_s

f_{wyd} : design yield strength of the shear reinforcing steel, 400N/mm² or less

α_s : angle of the shear reinforcing steel to the member axis

s_s : spacing of shear reinforcing steel

z : distance from location of compressive stress resultant to centroid of tensile steel, may generally be taken as $d/1.15$

γ_b : 1.10 in general

V_{fd} : design shear capacity of reinforcing fiber, given by Equation (6.3.5)

$$V_{fd} = (f_{vd}/\tan\beta_u) \cdot b_w \cdot z/\gamma_b \quad (6.3.5)$$

f_{vd} : design tensile yield strength of HPFRCC, $f_{vd}=0$ when f_{vd} is smaller than 1.5N/mm^2 .

β_u : angle of the diagonal crack surface to the member axis. $\beta_u = 45^\circ$.

γ_b : 1.3 in general

V_{ped} : component of effective tensile force in longitudinal prestressing steel parallel to the shear force, given by Equation (6.3.6).

$$V_{ped} = P_{ed} \cdot \sin\alpha_p/\gamma_b \quad (6.3.6)$$

P_{ed} : effective tensile force in longitudinal prestressing steel

α_p : angle of longitudinal prestressing to the member axis

γ_b : 1.1 in general

(2) Design shear capacity of a steel reinforced concrete member partly reinforced by HPFRCC shall be determined with appropriate methods such as tests. However, design shear capacity of a member combined with HPFRCC and normal concrete by appropriate technology may be determined according to section 6.3.3 "Design shear capacity of linear members" of Standard Specifications for Concrete Structures –*Structural Performance Verification* replacing HPFRCC with normal concrete.

(3) Design diagonal compressive capacity V_{wcd} of web-concrete in resisting shear force may be calculated using Equation (6.3.7).

$$V_{wcd} = f_{wcd} \cdot b_w \cdot d/\gamma_b \quad (6.3.7)$$

where $f_{wcd} : 1.25\sqrt{f'_{cd}}$ (N/mm^2) with $f_{wcd} \leq 7.8$ (N/mm^2) and γ_b ; 1.3 in general.

[Commentary] As shown in Equation (6.3.1), the design shear strength V_{yd} is given as the sum of the capacity exerted by HPFRCC's matrix V_{cd} , capacity exerted by HPFRCC's reinforcing fiber V_{fd} , and capacity exerted by shear reinforcing steels V_{sd} . It is possible to take advantages of HPFRCC in design by making use of the strong resistance offered by the reinforcing fiber. The method of considering the effects of reinforcing fiber in design formula is derived from *Recommendations for Design and Construction of Ultra High-Strength Fiber Reinforced Concrete Structures (Draft)*.

The capacity exerted by matrix is derived from Standard Specifications for Concrete Structures –*Structural Performance Verification*. However, V_{yd} is assumed to be reduced by a factor of 0.7 because HPFRCC allows cracks in service.

Figure 6.3.2 shows the verification results for the shear capacity equation using the specimens outlined in Fig. 6.3.1. Specimens A had a fiber content of 1.5% or 2.0% and shear reinforcement ratio of 0% or 0.15% or 0.3%, and specimen B had a fiber content of 2.0% and shear reinforcement ratio of 0%. Figure 6.3.2 indicates the shear capacity equation (6.3.1) generally allows a conservative evaluation of the shear capacity. It should be noted, however, that given the limited test data, an appropriate confirmation process such as by testing should be followed

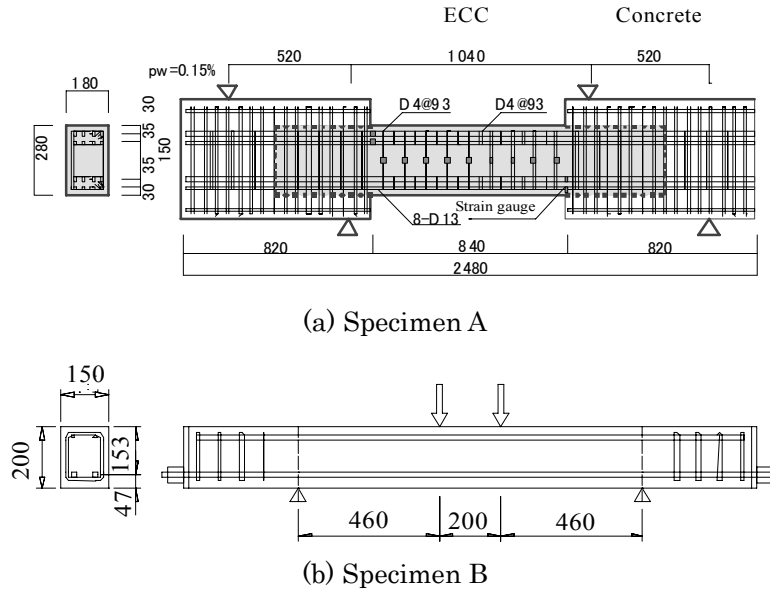


Fig. 6.3.1 Outline of shear test specimens

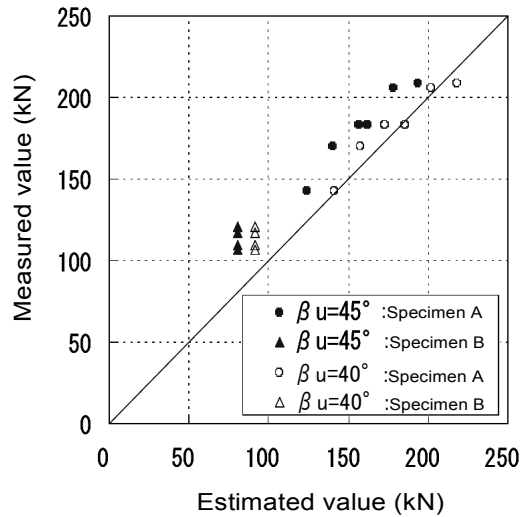


Fig. 6.3.2 Comparison of test and estimated values (Safety factor of estimated value is 1.0)

for cases where the cross-sectional height or reinforcement ratio is considerably different. According to *Recommendations for Design and Construction of Ultra High-Strength Fiber Reinforced Concrete Structures (Draft)*, a value of 40° is recommended for β_u when there is no axial force. If β_u is also set at 40° for HPFRCC not subjected to axial force, it means that the test values have been conservatively evaluated. Still, β_u is given as 45° here, due to the shortage of test data available.

(2) When a steel reinforced concrete member is partly reinforced by HPFRCC, a rational evaluation of shear capacity of such member is difficult because the sections of the member are governed by different reinforcing mechanisms according to the applied part. Thus this “Recommendations” document proposes other appropriate methods such as testing, while the design shear capacity of member combined with HPFRCC and normal concrete by appropriate

technology may be determined by replacing HPFRCC with normal concrete. This estimation is sufficiently on the safety side because the fiber shares major part of the shear capacity of the HPFRCC and V_{yd} shows to be sufficiently larger than the concrete-equivalent shear capacity, even V_{cd} is reduced by a factor of 0.7.

6.3.4 Examination of punching shear of planar members

(1) Design punching shear capacity of planar members subjected to local load V_{pd} shall be calculated by an appropriate empirical method such as by testing.

(2) Where an appropriate empirical approach such as testing is not taken, design punching shear capacity V_{pd} may be obtained by Equation (6.3.8) below.

$$V_{pd} = V_{pcd} + V_{pfd} \quad (6.3.8)$$

where,

V_{pcd} : design punching shear strength excluding the portion exerted by reinforcing fiber, given by Equation (6.3.9) below.

$$V_{pcd} = \beta_d \cdot \beta_p \cdot \beta_r \cdot f'_{cd} \cdot u_p \cdot d / \gamma_b \quad (6.3.9)$$

$$f_{vd} = 0.7 \times 0.20 \sqrt[3]{f'_{cd}} \text{ (N/mm}^2\text{)}, \text{ where } f'_{pcd} \leq 0.84 \text{ (N/mm}^2\text{)} \quad (6.3.10)$$

$$\beta_d = \sqrt[3]{1/d} \text{ (d : m) when } \beta_d > 1.5, \beta_d \text{ is taken as 1.5.}$$

$$\beta_p = \sqrt[3]{100p} \text{ when } \beta_p > 1.5, \beta_p \text{ is taken as 1.5.}$$

$$\beta_r = 1 + 1/(1 + 0.25u/d)$$

f'_{cd} : design compressive strength of concrete (N/mm²)

u : peripheral length of loaded area

u_p : peripheral length of design cross-section, calculated at a point $d/2$ away from the loading area .

d, p : effective depth and reinforcement ratio, respectively. Average values of reinforcing steel in the two directions.

γ_b : 1.3 in general

V_{pfd} : design punching shear capacity exerted by reinforcing fiber, given by Equation (6.3.11) below.

$$V_{pfd} = f_{vd} \cdot u_p \cdot d / \gamma_b \quad (6.3.11)$$

f_{vd} : design tensile yield strength of HPFRCC in the direction orthogonal to the diagonal crack direction , $f_{vd} = 0$ when f_{vd} is smaller than 1.5 N/mm².

γ_b : 1.3 in general

[Commentary] Where a planar member like a slab is subjected to local loading, the punching shear failure may occur in a manner that the portion right under the loaded area dents from surrounding region. Because it is difficult to obtain the punching shear capacity of a slab theoretically, an appropriate empirical process such as tests shall be followed to evaluate it. Where any appropriate empirical process such as tests is not taken, the punching shear capacity

may be expressed as the sum of the design punching shear capacity specified in Standard Specifications for Concrete Structures –*Structural Performance Verification* and reinforcing fiber's design punching shear capacity. However, V_{pcd} is assumed to be of 70 percent because HPFRCC allows cracks in service.

6.3.5 Design member forces in planar members subjected to in-plane forces

Principal in-plane forces may be adopted as the design member forces for planar members with HPFRCC.

[Commentary] By bearing part of tensile stress in a stable way, HPFRCC is supposed to contribute to the design capacity of a planar member subjected to in-plane forces. For this reason, the design member force is assumed to be the principal in-plane force, other than in the reinforcement arrangement direction.

6.3.6 Design capacity of planar members subjected to in-plane forces

The design capacity of planar members with HPFRCC shall be calculated by an appropriate method such as testing.

[Commentary] Due to the shortage of data, the portion of design planar member capacity exerted by HPFRCC should be calculated by an appropriate method such as testing.

6.3.7 Design shear transfer capacity

The design shear transfer capacity of HPFRCC members shall be calculated by an appropriate method such as testing.

[Commentary] Due to the shortage of data, HPFRCC's design shear transfer capacity should be calculated by an appropriate method such as testing.

6.3.8 Structural details

(1) No particular specifications are prescribed for the minimum number of stirrups when the design tensile yielding strength of HPFRCC is larger than 1.5 N/mm^2 . However in the other case, amount of shear reinforcement greater than 0.15% shall be arranged throughout the length of the linear member. The stirrup spacing shall in principle be less than 3/4 of the effective depth of the member and less than 400mm. This rule is not applicable to planar members

(2) Where the calculation results show that the linear member needs shear steel reinforcement, the stirrup spacing shall be less than 1/2 of the effective depth and less than 300 mm. In addition, the same amount of shear steel reinforcement shall be provided over a distance equal to the effective depth of member from the end of the region that is found to be in need of shear steel reinforcement in calculation.

(3) When stirrups are anchored in a tension region, an appropriate confirmation process such as testing shall be followed.

[Commentary] (1) In the case of a HPFRCC beam specimen with a HPFRCC's tensile yield strength of 3 N/mm^2 as shown in Fig. 6.3.3, the level of shear force exerted by 0.15% reinforcing fiber is more than 5 times that of the shear force exerted by shear reinforcing bars at a shear reinforcement ratio of 0.15%. HPFRCC beams do not exhibit brittle failure even after developing diagonal cracking because the reinforcing fiber shares tensile stress in a direction orthogonal to the crack plane. Thus, no particular specifications are prescribed for the minimum amount of steel shear reinforcement here.

(2) Where there is a need to provide shear steel reinforcement, the stirrups should be arranged according to Standard Specifications for Concrete Structures –*Structural Performance Verification*.

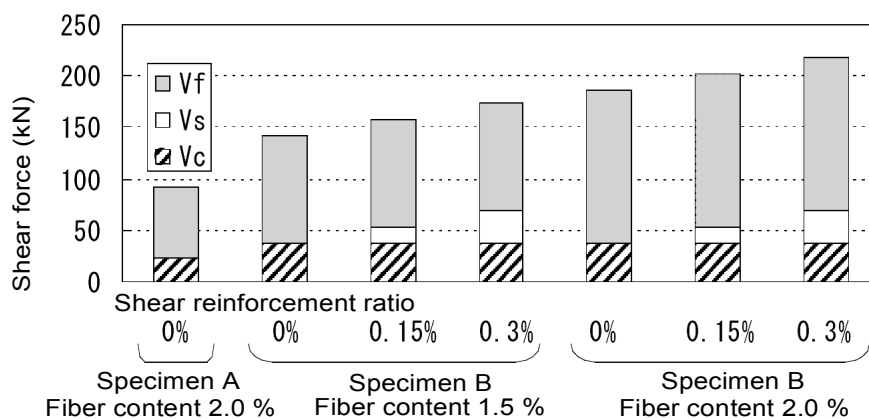


Fig. 6.3.3 Calculated components of shear resistance

(3) Being a highly ductile material that develops a number of dense micro-cracks, HPFRCC is expected to provide adequate bonding even when anchored in a tensile region. However, because the bond strength of HPFRCC anchored in a tensile region has yet to be clarified, an appropriate confirmation process such as testing should be adopted.

6.4 Examination of safety against torsion

(1) In principle, follow section 6.4 "Torsion" of Standard Specifications Concrete Structures –*Structural Performance Verification*.

(2) The torsional capacity of HPFRCC after initiating torsional cracking shall be calculated by an appropriate method such as testing.

[Commentary] Due to the shortage of data on the torsional capacity of HPFRCC after initiating torsional cracks, the safety should be examined by an appropriate method such as testing.

6.5 Examination of safety against fatigue

6.5.1 General

In principle, follow chapter 8 of Standard Specifications for Concrete Structures –*Structural Performance Verification*.

[Commentary] In HPFRCC, reinforcing fibers randomly distributed over the crack plane exhibit a bridging effect and control crack initiation and development. Formation of multiple fine cracks may enable a high energy absorption performance and may contribute to a higher fatigue resistance by the prevention of crack localization.

6.5.2 Verification of safety against fatigue

In principle, follow section 8.2 of Standard Specifications for Concrete Structures –*Structural Performance Verification*.

[Commentary] A flow diagram of the safety verification for fatigue on the basis of materials fatigue strength is shown in Fig. 6.5.1, where design variable stress σ_d may be given by the method shown in 6.5.4 of this “Recommendations” document. Using fatigue life N and the minimum stress or design stress at permanent load, design fatigue strength f_{rd} may be obtained according to the design fatigue strength formula in Standard Specifications for Concrete Structures –*Structural Performance Verification* for steel and according to section 3.9 of this “Recommendations” document for HPFRCC.

6.5.3 Design variable force and equivalent number of cycles

In principle, follow section 8.3 “Design variable force and equivalent number of cycles” in Standard Specifications for Concrete Structures –*Structural Performance Verification*.

6.5.4 Stress calculation due to variable loads

In principle, follow section 8.4 “Computation of stress due to variable load” in *Standard Specifications for Concrete Structures –Structural Performance Verification*

6.5.5 Design shear fatigue capacity of members

Design shear fatigue capacity of members shall in principle be estimated with appropriate methods such as testing where necessary.

[Commentary] Sufficient data are not accumulated to determine the design shear fatigue capacity of members, hence appropriate methods such as testing should be used where necessary.

6.6 Examination of safety against rigid body stability

In principle, follow section 6.5 “Rigid body stability” of Standard Specifications for Concrete Structures –Structural Performance Verification.

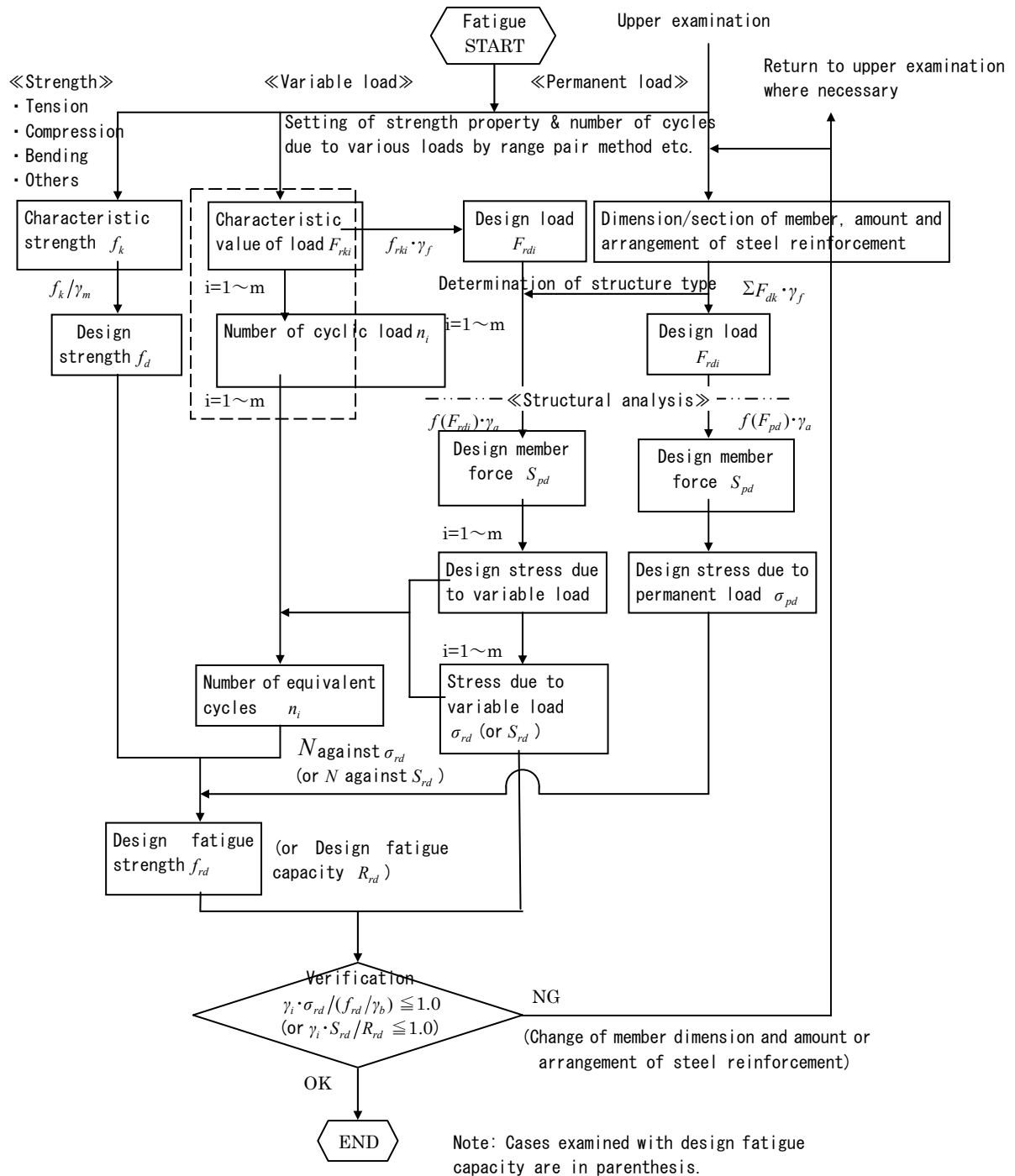


Fig. 6.5.1 Flow diagram for examining the limit state fatigue

Chapter 7 Serviceability Verification of Structures

7.1 General

- (1) It shall be verified that structures with HPFRCC satisfy the required serviceability during the design life.
- (2) Serviceability of structures shall be in principle verified such that the structure or structural members does not reach the serviceability limit state under the design load.
- (3) The serviceability limit states shall be represented by indices such as stress, strain, displacement/deformation, crack and vibration, and be verified with appropriated methods.
- (4) Other serviceability limit states shall be set up and verified with appropriate methods, as necessary.

[Commentary] Structures or structural members should maintain sufficient functions suitable for the purpose of their usage during their design service life. The required function includes structural safety, amenity, water-tightness, aesthetics and durability throughout the design service life. Necessary limit states should be determined with respect to each required function and verified with appropriate methods whose accuracy and applicable range are clarified.

7.2 Calculation of stress and strain

Calculation of stress and strain in HPFRCC and steel at a limit state of serviceability shall be based on the following assumptions.

- (i) Strain is proportional to the distance from the neutral axis of the cross section.
- (ii) HPFRCC is linear elastic under compression and follows the tensile stress-strain curve as shown in section 3.3.1 under tension.
- (iii) Steel is linear elastic.
- (iv) Young's modulus of HPFRCC is given in Chapter 3.

[Commentary] Calculation of stress and strain in a cross section is needed to examine the serviceability. In the calculation HPFRCC is assumed to be elastic under compression and perfectly elastoplastic under tension to take into account the tensile performance. HPFRCC shows pseudo strain-hardening, similar to the strain-hardening of steel, under uniaxial tension. Thus HPFRCC can bear tensile stresses in the tension zone as shown in Fig. 7.2.1 of stress and strain distributions under the serviceability limit state. Tensile strength of HPFRCC is greater than tensile yield strength, however, the stress-strain curve in the tension zone for design may be treated similar to that of steel and assumed to behave as a perfect elastoplastic body as shown in Fig. 7.2.2. In this state, the Young's modulus in tensile stress may be regarded as that in compression. When tensile stress of HPFRCC exceeds the elastic limit due to long term loading, computation of stress and strain needs to be made taking appropriately into account the creep deformation of HPFRCC.

Stress and strain distributions of the specimen made entirely with HPFRCC are shown in Fig. 7.2.1. When HPFRCC is used at the tension side only, the stress distribution may be estimated taking only the tensile stress of HPFRCC into account neglecting the tensile stress of normal concrete. With a thickness greater than 5 mm, HPFRCC that is made with sprayed PVA fiber and arranged only in the tension side of a member was confirmed to form multiple fine cracks capable of controlling the crack width while the construction accuracy of the thickness should be appropriately estimated.

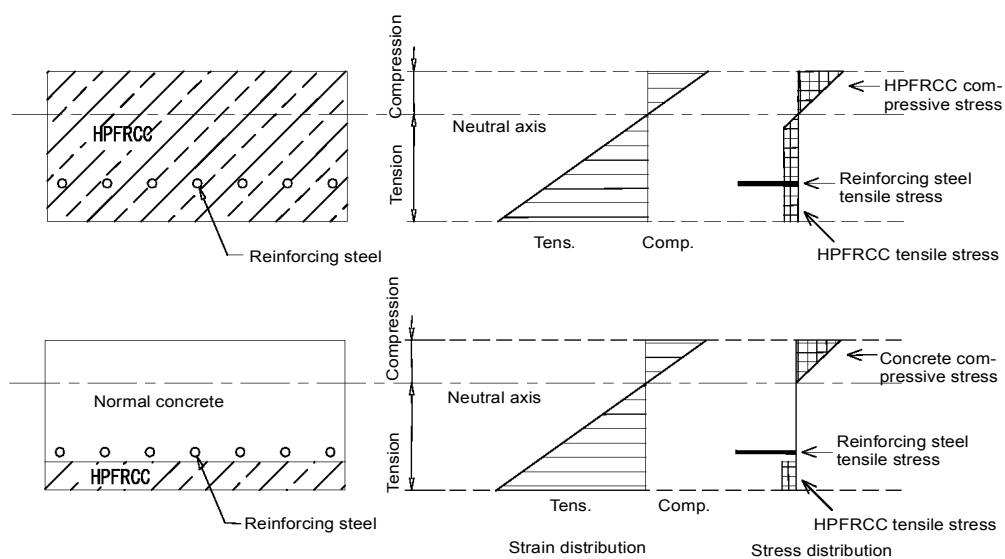


Fig. 7.2.1 Stress and strain distributions in an HPFRCC

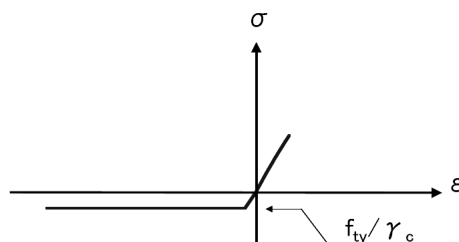


Fig. 7.2.2 Stress and strain relation of HPFRCC used for examination of serviceability limit state design

7.3 Stress limit value

Compressive stress of HPFRCC due to bending moments and axial forces and tensile stress of steel shall not exceed the limit values given in (1) and (2).

(1) Limit value of compressive stress due to bending moment and axial forces of HPFRCC are $0.4f_{ck}$ under permanent load where f_{ck} is a characteristic value of compressive strength of HPFRCC.

(2) Limit value of steel tensile stress is f_{yk} , where f_{yk} is a characteristic value of tensile yield strength of steel.

[Commentary] When HPFRCC is permanently subjected to multi-axial constraints, the limit value may be mitigated with an appropriate evaluation method.

The tensile stress of the steel may be limited by the yield stress, because the assumptions for structural analysis and stress computation in section 7.2 of the “Recommendations” document are no longer valid due to the tensile stress of steel exceeding the elastic limit. When cracking is examined for normal concrete, stress in reinforcing steel is sufficiently smaller than the characteristic value of tensile yielding strength. However for HPFRCC members, stress in reinforcing steel is not smaller than the characteristic value of tensile yielding strength due to the large deformation capability of HPFRCC, hence a verification taking into account the influence of creep deformation of HPFRCC is necessary whether the stress in reinforcing steel in the long term is not larger than the characteristic value of tensile yielding strength.

7.4 Strain limit value

Tensile strain of HPFRCC due to bending moments and the axial forces shall not exceed the limit value that may be determined with appropriate tests.

[Commentary] Because HPFRCC has excellent crack dispersibility and crack width control capability, a crack behavior with multiple fine cracks of less than 0.2 mm wide can be seen at a tensile strain of 0.2 to 1 percent as illustrated in Fig. 3.10.2, and Fig. 3.10.3. Relationship between crack width and tensile strain of HPFRCC may be determined with tensile test as shown in the practical example of Fig. 3.10.1 (b). Also the tensile strain limit at the serviceability verification may be set with a sufficient safety margin against ultimate tensile strain. This is because HPFRCC exhibits strain-hardening characteristic under direct tensile stress and is confirmed the absence of tensile creep fracture at design tensile yield strength under tensile creep test in section 3.8.

Tensile strain capacity of HPFRCC is normally five to ten times greater than the yield strain of steel. Thus the limit value of tensile strain based on appropriate testing taking into account the characteristics of the structure may be determined when HPFRCC is applied to steel-HPFRCC composite structures. It is recommended that the limit value of tensile strain for materials with an established crack width-tensile strain relation in appendix II-1 may be set to a range from 0.2 to

0.5 percent and less than the design ultimate tensile strain when repeated load is taken into account at the service condition.

7.5 Examination of tensile strain

- (1) Tensile strain of HPFRCC due to bending moments and axial forces shall not exceed the limit value shown in section 7.4.
- (2) Diagonal tensile strain due to shear forces, torsional moments and axial forces shall not exceed the limit value given in section 7.4.
- (3) The strains induced by shrinkage of HPFRCC shall be taken into account if necessary in the verification of tensile strain capacity.

[Commentary] (1) In this “Recommendations” document, cracks are allowed for HPFRCC under service conditions exhibiting pseudo strain-hardening characteristics, hence the method of determining tensile strain after cracking is specified. Tensile strain should be lower than the limit value over which the crack width control capability of HPFRCC is no longer given.

(2) Tensile strain evaluated with an appropriate analysis should be in principle lower than the limit value even when the stress resultant responsible for tensile strain is other than bending moment and axial force.

(3) Shrinkage strain of HPFRCC is of the same level as that of ordinary concretes and it may be taken into account, if necessary, in the verification of tensile strain capacity.

7.6 Examination of cracking

7.6.1 General

(1) Cracks in HPFRCC due to bending moments, shear forces, torsional moments and axial forces shall be examined with appropriate methods determining whether safety and serviceability of structure are impaired.

(2) Examination of cracks in terms of resistance to environmental actions is essentially a control of crack width in HPFRCC surfaces under specified environmental conditions and not to allow steel corrosion associated with ingress of chloride ions and carbon dioxide and resulting degradation of required performance of structures during design service life. Examination may be accomplished by confirming the following (i) and (ii) with the method specified in Chapter 9.

(i) Crack width of HPFRCC is less than the permissible width for steel corrosion determined under specified environmental conditions, cover thickness, design service life and other factors.

(ii) Predicted chloride ion concentration at steel reinforcement in HPFRCC under specified environmental conditions, cover thickness, HPFRCC quality level and crack width is lower than the permissible concentration for initiation of steel corrosion during service life.

Evaluation of cracks is not necessary for temporary structures, structures with very short design service life and structures with surface protection.

(3) When water tightness is an important factor, an appropriate permissible crack width may be specified, and then be confirmed that crack widths are less than the permissible value.

(4) When appearance is an important factor, an appropriate permissible crack width may be specified, and then be confirmed that any crack widths are less than the permissible value.

[Commentary] (1) Cracks in a structure may cause degradation of performance such as safety and serviceability due to steel corrosion. Thus the crack in HPFRCC should be evaluated with appropriate methods in terms of safety, serviceability and resistance to environmental actions.

Among various causes for cracking in HPFRCC structures, this section essentially addresses cracks due to load, especially bending moments, shear forces, torsional moments and axial forces. When a structural system changes during construction and the service life, the stress resultant should be evaluate taking into account of these changes.

(2) When verifying the resistance to environmental actions in terms of cracks, protection of steel from corrosion due to chloride ion ingress can be accomplished not only by the crack width control capability but also by cover thickness and HPFRCC quality. Based on this fact, examination of limit state of cracks for resistance to environmental actions shall be made, in principle, by confirming both that crack width is less than the permissible width and that predicted chloride ion concentration at the steel reinforcement is lower than the permissible concentration for initiation of steel corrosion during service life.

HPFRCC material has a capability of controlling crack width to be sufficiently fine and chloride ion permeability to HPFRCC with distributed cracks shall be estimated by a formula shown in equation (3.3.2) in appendix II-3 using maximum crack width and strain in HPFRCC. Thus the unified examination of tensile strain, cracking and the resistance to environmental actions (Chapter 9 of this “Recommendations” document) shall be possible provided that the relation between crack width – tensile strain – chloride ion permeability is determined experimentally beforehand.

(3) When water tightness is an important factor, examination of cracking should be made in terms of crack initiation or crack width control.

(4) When appearance is an important factor, a permissible crack width should be specified when necessary, and examination of cracking shall be made by a method similar to that for durability

7.6.2 Permissible crack width

In principle, follow section 7.4.2 “Permissible crack width” of Standard Specifications of Concrete structures –*Structural Performance Verification*.

[Commentary] The capability of controlling crack width is a major characteristic of structural members using HPFRCC. Previous studies show that the crack width of HPFRCC can be regarded as a material property rather than structural property under given cross sectional dimensions or loading conditions. Hence, for the design of structural members using HPFRCC,

the resistance to environmental actions such as chloride ion ingress should be examined by using the crack control property of the HPFRCC as specified in Chapter 9 of this “Recommendations” document. However, use of HPFRCC over the range of crack width greater than that allowed for the normal reinforced concrete members is not of significance and the data covering the range of the crack width are not sufficient, thereby this “Recommendations” document is in principle based on the permissible crack width range of the normal reinforced concrete.

7.6.3 Classification of environmental conditions

In principle, follow section 7.4.3 “Classification of environmental conditions” of Standard Specifications for Concrete structures –*Structural Performance Verification*.

7.6.4 Examination of bending cracks

- (1) Examination of crack width is not necessary when the tensile stress of HPFRCC due to bending moments is lower than the cracking strength of HPFRCC.
- (2) Crack width shall be examined by confirming that the maximum crack width obtained from tensile strain in HPFRCC is lower than the permissible crack width specified in section 7.6.2
- (3) Relationship between maximum crack width and tensile strain shall be determined, in principle, by uniaxial tensile test.

[Commentary] (1) Examination of bending crack is not necessary when the bending crack does not occur at the limit state of serviceability. However, in cases when there is a high risk of cracking, such as thermal cracking, which are normally excluded in the examination of the serviceability limit state, an examination using appropriate method shall be carried out to prevent such racking. Tensile stress due to autogenous shrinkage may become significant in a HPFRCC with high volume powder component. This factor shall be taken into consideration.

(2), (3) Unlike ordinary concrete, HPFRCC has the capability of controlling crack width. The stress-strain relationship of HPFRCC obtained by uniaxial tensile test (see Testing Method 2, 3 and 4) and the crack width-strain relationship are shown in Fig. 7.6.1. The comparison of crack widths between steel reinforced HPFRCC and monolithic HPFRCC under the tensile test is shown in Fig. 7.6.3. Crack width of HPFRCC reinforced with steel bar was equivalent to or smaller than that without steel reinforcement. Thus the relation between crack width of HPFRCC and tensile strain can be designed conservatively by using a design formula derived from material tests without steel reinforcement. Thereby for the materials with a formulated crack width-tensile strain relation in appendix II-1, verification of crack width can be made first by estimating the maximum crack width from the tensile strain of HPFRCC, and next by comparison with the permissible crack width.

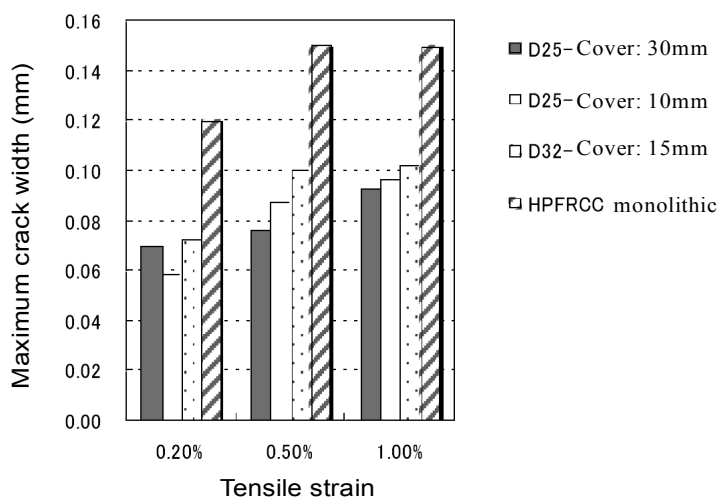


Fig. 7.6.3 Comparison of maximum crack width between steel reinforced HPFRCC and monolithic HPFRCC under tensile test

7.6.5 Examination of shear cracks

In principle, follow section 7.4.6 “Examination of shear cracks” of Standard Specifications for Concrete structures –*Structural Performance Verification*.

7.6.6 Examination of torsional cracks

In principle, follow section 7.4.7 “Examination of torsional cracks” of Standard Specifications for Concrete structures –*Structural Performance Verification*.

7.6.7 Structural details

Additional reinforcements to control cracks due to temperature changes and shrinkage are not necessary provided that the characteristic value of the maximum crack width of HPFRCC is less than the crack width shown in section 7.6.2.

[Commentary] HPFRCC has a crack width control capability. Hence, additional reinforcement is not necessary provided that the characteristic value of the maximum crack width of HPFRCC is less than the permissible crack width.

7.7 Examination of deflection and displacement

(1) Short-term deflection and displacement shall be evaluated using the stress-strain relation of HPFRCC as described in section 7.2 (ii).

(2) Long-term deflection and displacement shall be evaluated using the stress-strain relation of HPFRCC as described in section 7.2 (ii) and taking into account the effects of creep and shrinkage.

[Commentary] Tensile performance of HPFRCC is in principle included in structural design in this “Recommendations” document. Calculation of deflection and displacement, like that of stress and strain, is based on the assumption that the tensile stress-strain relation of HPFRCC is perfectly elastoplastic. The reasons are:

- Stress-strain curve at a cracked area is equivalent to the averaged one because numerous cracks occur in HPFRCC.
- The converted geometrical moment of inertia used for the calculation of deflection of normal reinforced concrete member subjected to cyclic load is nearly equivalent to that of cracked section where the tensile stress in concrete is ignored.
- Young’s modulus of HPFRCC is approximately one half of normal concrete but HPFRCC can bear tensile forces. Thus the effective stiffness of an HPFRCC member is almost equivalent to that of normal reinforced concrete members.

Although Young’s modulus of HPFRCC is approximately one half of normal concrete as shown in Fig. 7.7.1, the tensile performance of HPFRCC can be included in strain/deflection calculations, and the bending stiffness is equal or greater than that of normal reinforced concrete members.

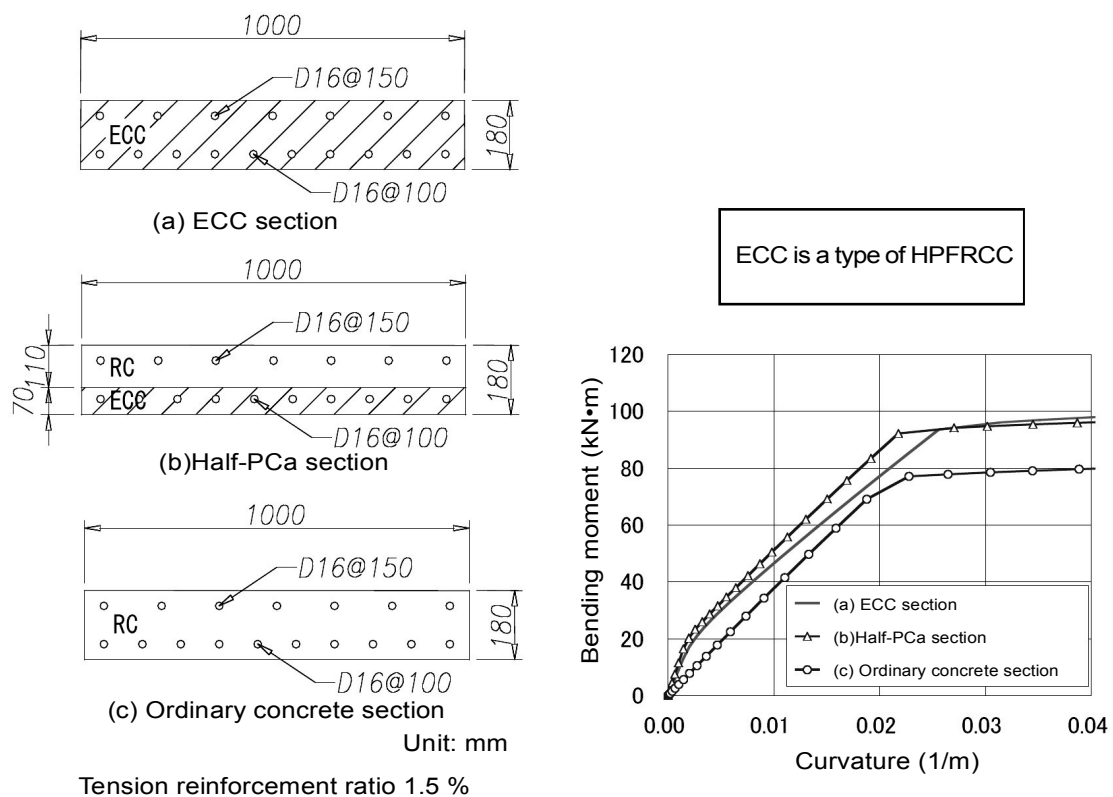


Fig. 7.7.1 Example calculation of deflections for ordinary concrete, HPFRCC half-PCa (precast) and ECC members.

7.8 Examination of vibration

Examination of vibration due to variable loads shall be carried out using appropriate methods to ensure that functions and serviceability of structure are not impaired.

[Commentary] Attentions should be paid that the thickness of structural member becomes thinner when HPFRCC is applied and the natural period tends to become longer compared to the normal concrete structures.

Chapter 8 General Structural Details

8.1 General

This chapter addresses specific structural details that shall be applied in the design of HPFRCC structures. When specific structural details of each member or structural type are specified, they shall also be complied with.

[Commentary] Structural details, also specified in other chapters, are applied only to the members or structural systems covered in the respective chapters. If it is found impossible to follow provisions given here as a result of complying with the specific structural details specified in another chapters, the latter should have priority over the general provisions given here.

Major structural details specified in other chapters are as follows.

6.2.2 Structural details

6.3.8 Structural details

7.6.7 Structural details

8.2 Concrete cover

(1) Concrete cover shall be determined to secure the adequate bond strength, as a prerequisite to the performance verification of HPFRCC structures, taking account of the required resistance to environmental actions, importance of the structure and construction errors.

(2) In principle, the minimum cover thickness for reinforcing bar shall be larger than one-half of the diameter of the reinforcing bar to secure adequate bond strength.

(3) To determine the minimum thickness of concrete cover in consideration of resistance to environmental actions, refer to Chapter 9.

(4) The minimum concrete cover shall be set at a value obtained by the method described in (2) or (3), whichever is greater.

[Commentary] Bending tests on beam specimens, having a concrete cover thickness of one-half of the reinforcing bar diameter and lap splices of D25 tension reinforcement, have confirmed that it is possible to apply the basic development length equation specified in section 9.5.5 “Basic development length” of Standard Specifications for Concrete Structures - *Structural Performance Verification*. With regard to resistance to environmental actions, it has been confirmed that HPFRCC’s carbonation rate is almost the same as that of the normal concrete with the same water-cement ration (c.f. appendix II-2 “Carbonation Resistance of HPFRCC”). It has been confirmed that the chloride ion ingress rate in cracked HPFRCC is smaller than that in cracked ordinary concrete (c.f. appendix II-3 “Chloride Ion Permeability to HPFRCC”). Therefore, in the context of resistance to environmental actions, smaller concrete covers may be required to

HPFRCC structures than in ordinary concrete structures. Here, the minimum concrete cover is set at a value to secure adequate bond strength or at a value to secure resistance to environmental actions, whichever is greater.

8.3 Spacing of steel bars

- (1) In principle, the necessary longitudinal reinforcement spacing shall be larger than the diameter of reinforcing bar to secure adequate bond strength.
- (2) There shall be horizontal and vertical spacings that are larger than the fiber length to enable proper placement and compaction of HPFRCC.
- (3) The minimum spacing shall be a value obtained in (1) or (2), whichever is greater.

[Commentary] (1) Bending tests on beam specimens, having a concrete cover thickness of one-half of the reinforcing bar diameter and lap splices of D25 tension reinforcement, have confirmed that it is possible to apply the basic development length equation specified in section 9.5.5 “Basic development length” of Standard Specifications for Concrete Structures - *Structural Performance Verification*. The minimum spacing is set equal to the diameter of the reinforcing bar because the concrete cover and the half of rebar spacing are equivalent in the basic development length equation.

(2) Given here is the minimum spacing that is necessary for adequately distributing HPFRCC around the tension reinforcement.

(3) Here, the minimum spacing is given as a spacing needed to ensure adequate bond strength, or a spacing that is given in consideration of proper placement and compaction of HPFRCC, whichever is greater.

8.4 Development of steel bars

8.4.1 General

In principle, refer to section 9.5.1 “General” of Standard Specifications for Concrete Structures - *Structural Performance Verification*.

8.4.2 Development performance

In principle, refer to section 9.5.2 “Performance of anchorages of reinforcement in concrete” of Standard Specifications for Concrete Structures - *Structural Performance Verification*.

8.4.3 Critical sections to check development of reinforcement

In principle, refer to section 9.5.3 “Critical sections to check development of reinforcement” of Standard Specifications for Concrete Structures - *Structural Performance Verification*.

8.4.4 Development length for reinforcement

In principle, refer to section 9.5.4 “Development length for reinforcement” of Standard Specifications for Concrete Structures - *Structural Performance Verification*.

8.4.5 Basic development length

(1) Basic development length of tension reinforcement l_d can be obtained by Equation (8.4.1), provided it is 20ϕ or greater.

$$l_d = \alpha \frac{f_{yd}}{4f_{bod}} \phi \quad (8.4.1)$$

where,

ϕ : diameter of main reinforcement

f_{yd} : design tensile yield strength of reinforcement

f_{bod} : design bond strength of HPFRCC, which can be obtained by Equation (8.4.2).

$$f_{bod} = 0.28 f'_{ck}{}^{2/3} / \gamma_c \quad (8.4.2)$$

providing, $f_{bod} \leq 3.2$ (N/mm²)

f'_{ck} : characteristic compressive strength of HPFRCC (N/mm²).

γ_c : setting at 1.3 is allowable.

$$\begin{aligned} \alpha &= 1.0 \quad (k_c \leq 1.0) \\ &= 0.9 \quad (1.0 < k_c \leq 1.5) \\ &= 0.8 \quad (1.5 < k_c \leq 2.0) \\ &= 0.7 \quad (2.0 < k_c \leq 2.5) \\ &= 0.6 \quad (2.5 < k_c) \end{aligned}$$

where,

$$k_c = \frac{c}{\phi} + \frac{15A_t}{s\phi}$$

c : concrete cover under main reinforcement or a half of the anchored rebar spacing, whichever is smaller

A_t : sectional area of transverse reinforcement perpendicular to the assumed splitting failure section

s : central clearance of transverse reinforcement

(2) The basic development length of compressive reinforcement is set at a value 0.8 times the value of l_d obtained in (1).

(3) Where the tension reinforcement has standard hooks, deduction of 10ϕ from basic development length l_d is allowed. Nonetheless, it is preferable to set basic development length of rebar l_d at 20ϕ or greater.

[Commentary] (1) The calculation of basic development length is based on Standard Specifications for Concrete Structures - *Structural Performance Verification*. Figure 8.4.2 shows the study results for the applicability of Equation (8.4.1) using the lap-spliced specimens shown in Fig.8.4.1. Note that the specimens were designed with a fiber content of 2.0%, tension reinforcement of D25 and a minimum concrete cover of 10mm. For the D25 tension reinforcement, it is possible to obtain a conservative value of development length by Equation (8.4.1), even where concrete cover is set at 10mm.

HPFRCC is assumed to bring about restraining effects similar to those by transverse reinforcement because, with the fiber's bridging effects, it can bear tensile force even after cracks have developed. However, due to the lack of sufficient data, the calculation of basic development length should be based on Standard Specifications for Concrete Structures - *Structural Performance Verification*.

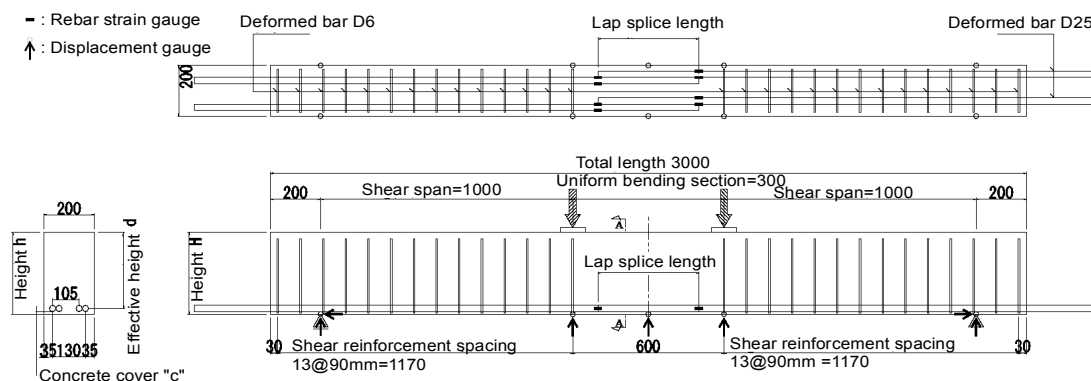


Fig.8.4.1 Outline of specimen

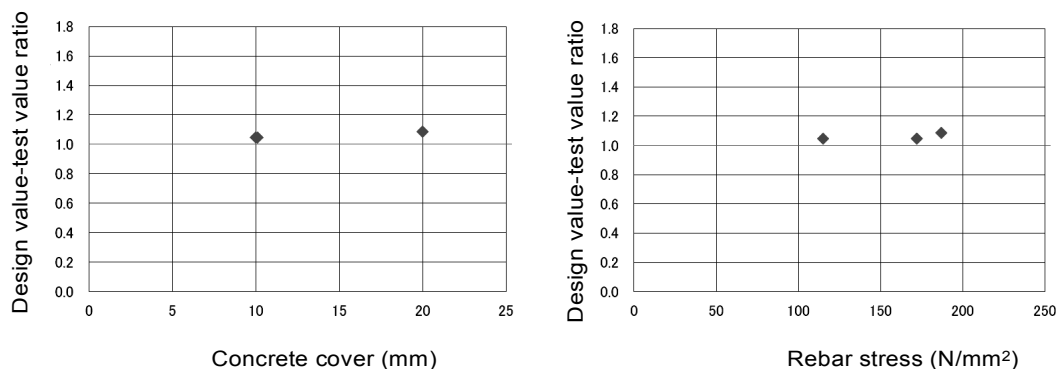


Fig. 8.4.2 Applicability of basic development length equation: Study results

8.5 Splices in reinforcement

8.5.1 General

- (1) Splices shall be selected according to such factors as the type, diameter, and stress condition of reinforcing bars and splices.
- (2) Splices shall not be located at cross sections of members subject to high stresses to the extent possible.
- (3) In principle, splices shall not be concentrated on the same cross section of a member. To do so, the longitudinal distance between two staggered splices shall basically be larger than a value obtained by joint length plus a value 25 times the value of reinforcing bar diameter or plus the section height, whichever is greater.
- (4) The clearance between a splice and neighboring reinforcing bars or between splices shall be larger than the length of reinforcing fiber.
- (5) When splicing is carried out after arranging reinforcing bars, a clearance shall be given to allow for insertion of joint installation tools and equipment.
- (6) Concrete cover over splices shall satisfy the provisions given in section 8.2.

[Commentary] The provisions here are based on section 9.6.1 “General” of Standard Specifications for Concrete Structures - *Structural Performance Verification*. However, the clearance between joints is made larger than the length of reinforcing fiber because HPFRCC contains a comparatively small amount of aggregates.

8.5.2 Lap splices

In principle, refer to section 9.6.2 “Lap Splices” of Standard Specifications for Concrete Structures - *Structural Performance Verification*.

[Commentary] Because HPFRCC can bring about restraining effects similar to those by transverse reinforcement with the fiber’s bridging effects, it can bear tensile force even after cracks have developed. Thus, it may require shorter laps for splices and less transverse reinforcement than ordinary concrete. However, due to the lack of sufficient data, these values should be referred to Standard Specifications for Concrete Structures - *Structural Performance Verification*.

8.5.3 Performance of splices

In principle, refer to section 9.6.3. “Performance of splices of reinforcement in concrete” of Standard Specifications for Concrete Structures - *Structural Performance Verification*.

8.6 Construction Joint

- (1) The locations and direction of construction joints shall be determined not to damage the strength, appearance and durability of the structure.
- (2) It is preferable that construction joints are clearly indicated in the design drawings.

[Commentary] Because the locations and direction of construction joints significantly affect the strength of structure, construction joints should be installed in locations where the shear force is relatively small and in a direction perpendicular to the compressive force working on HPFRCC, using methods whose validity is confirmed beforehand.

Chapter 9 Verification for Resistance to Environmental Actions

9.1 General

In principle, HPFRCC structures shall be verified to maintain the required performance throughout the design service life using appropriate methods taking into account their service conditions and environmental factors.

[Commentary] To verify the resistance to environmental actions of an HPFRCC structure, appropriate methods that take into account the service conditions and environmental factors should be applied.

9.2 Verification of steel corrosion due to carbonation

(1) In principle, the concrete cover of a structure using an HPFRCC shall be determined so that the structure's required performance will not deteriorate due to carbonation of HPFRCC.

(2) Carbonation is verified by confirming that the carbonation depth, which is obtained by adding the characteristic value of predicted carbonation depth during the design service life to the uncarbonated cover depth, multiplied by the structure factor, does not exceed the concrete cover.

(3) The HPFRCC's carbonation rate shall be derived from test results or other appropriate methods.

(4) Reinforcing steel corrosion due to carbonation of HPFRCC can be examined in the same manner as in the uncracked state provided that the maximum crack width of HPFRCC is less than the permissible crack width as specified in section 7.6.2

(5) When determining the corrosion rate of steel reinforcement embedded in HPFRCC, a smaller value than that of normal concrete can be assumed because of the large anode/cathode area ratio in HPFRCC.

[Commentary] (1) & (2) Verification of steel corrosion due to carbonation should be based on Standard Specifications for Concrete Structures – *“Materials and Construction”*. Here, it is deemed sufficient to confirm that the carbonation depth is less than the critical level to initiate steel corrosion. The carbonation depth of HPFRCC can be set at 10mm where there is no chloride ingress, as prescribed in Standard Specifications for Concrete Structures – *“Materials and Construction”*. Where chloride ingress is present, the uncarbonated cover depth should be determined properly by a survey or tests to take into consideration the influence of chlorides.

(3) An equation that is proportional to the square root of service life can be used as the prediction formula for the carbonation depth. In doing so, it is important to determine the coefficient of carbonation rate properly, based on test results or other relevant data. Figure. 9.2.1 shows an

example of the results of past tests on the coefficient of carbonation rate of HPFRCC (c.f. appendix II-2 “Carbonation Resistance of HPFRCC”). As shown in Fig.9.2.1, in the case of uncracked HPFRCC, it is confirmed that the coefficient of carbonation rate is more or less the same as that of ordinary concrete with the same w/c.

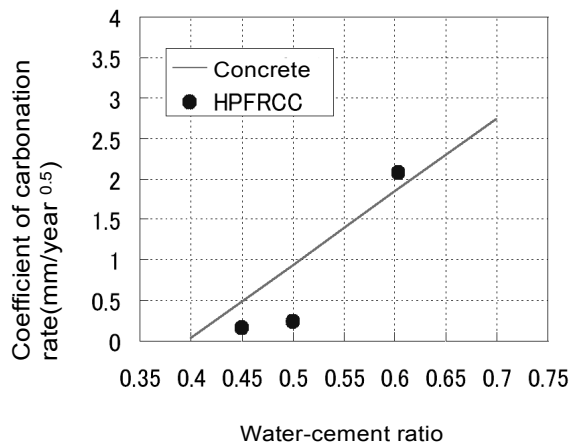


Fig.9.2.1 Relationship between material and coefficient of carbonation rate in the non-cracked region

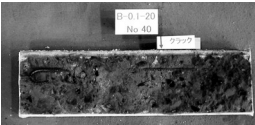
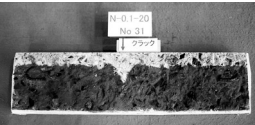
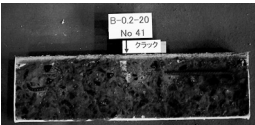
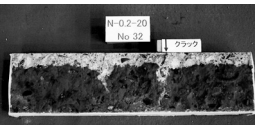
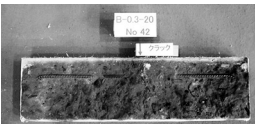
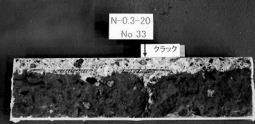

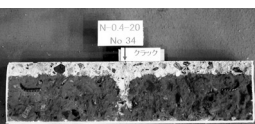
Maximum crack of concrete at the ECC-concrete Interface (mm)	ECC shotcrete (A 10mm of sprayed ECC on concrete)	Unreinforced specimen (Concrete only)
0.1		
0.2		
0.3		
0.4		

Photo.9.2.1 An example of accelerated carbonation test

(4) When HPFRCC is installed at the surface of structures, its carbonation prevention effect can be expected due to the crack control capability of HPFRCC as shown in Photo 9.2.1, and the steel corrosion due to carbonation of cracked HPFRCC can be estimated verifying that the maximum crack width is less than the permissible crack width.

(5) Steel corrosion tests on cracked specimens have confirmed that the corrosion of steel reinforcement surrounded by HPFRCC is suppressed due to a large anode/cathode area ratio. This is due to the fact that the anodic reaction in the cracked region is restrained by HPFRCC's crack width control capability and crack dispersibility, and so is the cathodic reaction by the crack width control capability (Fig.9.2.2). Note that the minimum HPFRCC thickness that is expected to bring about the crack width control capability and crack dispersibility is set at 10mm.

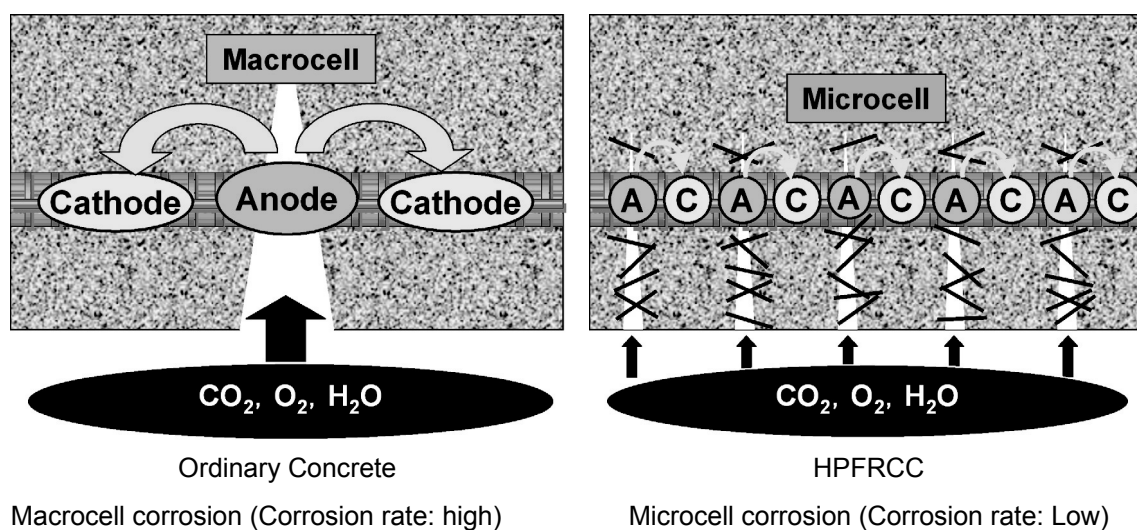


Fig.9.2.2 Corrosion cell pattern differences by crack development mode

9.3 Verification of chloride induced steel corrosion

(1) In principle, the cover depth of an HPFRCC structure shall be determined so that the structure's required performance will not be lost due to chloride ion ingress into HPFRCC.

(2) Steel corrosion as a result of chloride ion ingress is verified by confirming, at the designed cover thickness, that the designed chloride ion concentration at the steel reinforcement does not exceed the critical level to initiate corrosion during the designed service life.

(3) The critical chloride concentration for initiation of steel corrosion shall be determined based on test results or other relevant data. It may be normally taken as 1.2 kg/m^3 .

(4) The design value of chloride ion permeability of HPFRCC shall be properly determined based on test results or other relevant data taking into account the effects of induced tensile strain and crack width that occur in HPFRCC under service conditions.

(5) When determining the corrosion rate of steel reinforcement in HPFRCC, it is basically allowable to assume a lower value than that of normal concrete due to the large anode/cathode area ratio.

[Commentary] Because of the low water-binder ratio and the presence of additives, HPFRCC is less prone to chloride ion ingress than the standard ready-mixed concrete and shows a possibility of high resistance to salt damage to HPFRCC structure.

(1) & (2) When verifying the performance of structures against chloride ion ingress, it is most straightforward and conservative to require that steel reinforcement does not suffer corrosion during the service life. Thus, verification whether the chloride ion concentration at the reinforcing bar is lower than the critical chloride concentration for initiation of steel corrosion is executed with the procedure specified in Table 9.3.1.

Step 0: According to section 7.2 of the “Recommendations”, estimate the design tensile strain that occurs at the tension region of HPFRCC member in service.

Step 1: Based on the design tensile strain, the maximum crack width is calculated according to the example relation shown in Fig. 9.3.1.

Step 2: The design chloride ion permeability is calculated with the maximum crack width and the design tensile strain according to section 9.3 of the “Recommendations.”

Step 3: The chloride ion concentration at the reinforcing bar in the design service life of structure is determined using chloride ion permeability, design service life specified in section 2.2 of the “Recommendations” and design cover thickness.

Step 4: Verification is completed if the chloride ion concentration at the reinforcing bar in the designed service life is lower than the critical chloride concentration for initiation of steel corrosion prescribed in section 9.3 (3) of the “Recommendations.”

Table 9.3.1 Verification flow for steel corrosion associated with chloride ion ingress

Step	Subject	Input	Output
0	Estimation of strain according to chapter 7 Serviceability verification of structures	(Omitted)	Tensile strain of HPFRC at tension end of a member
1	Estimation of maximum crack width	Design tensile strain of HPFRCC	Characteristic value of maximum crack width of HPFCC
2	Estimation of chloride ion permeability	Maximum crack width and tensile strain of HPFRCC	Design chloride ion permeability of cracked HPFRCC
3	Estimation of chloride ion concentration at steel reinforcement	Design chloride ion permeability of cracked HPFRCC, design service life and design cover thickness	Design chloride ion concentration at reinforcing bar in design service life of concrete structure.
4	Verification of steel corrosion	Design chloride ion concentration at steel reinforcement in the design service life, critical chloride ion concentration for steel corrosion	Critical chloride ion concentration for steel corrosion should be greater than the design chloride ion concentration at reinforcing bar in design service life of concrete structure. [End of verification]

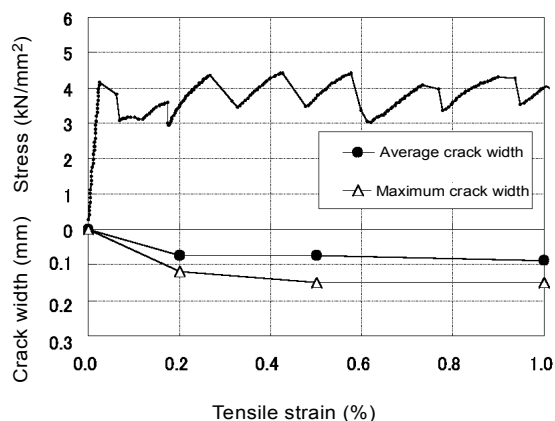


Fig.9.3.1 Relationship between tensile strain and maximum crack width

(3) The critical chloride concentration for initiation of steel corrosion at reinforcing bar is typically 1.2 kg/m^3 as specified in Standard Specifications for Concrete Structures – *Materials and Construction*, which may also be applied to that of HPFRCC. Here the chloride ion concentration refers to total chloride mass per volume.

Because HPFRCC has high unit cement content and various types of admixture, the amount of fixed chloride ion such as Friedel’s salt, may increase leading to a higher critical chloride ion concentration for steel corrosion. A immersion test with a 10% NaCl solution confirmed that amount of soluble salts against total chloride was approximately 0.2 to 0.4 in HPFRCC while that of normal concrete with a W/C of 0.5 ranges from 0.6 to 0.8 as shown in Fig. 9.3.2. See appendix II-3 “Chloride Ion Permeability to HPFRCC”. Thus such data and other inspection results can be used if they contribute to an appropriate determination of the critical chloride concentration for initiation of steel corrosion.

(4) Design value of chloride ion permeability of HPFRCC should in principle determined taking

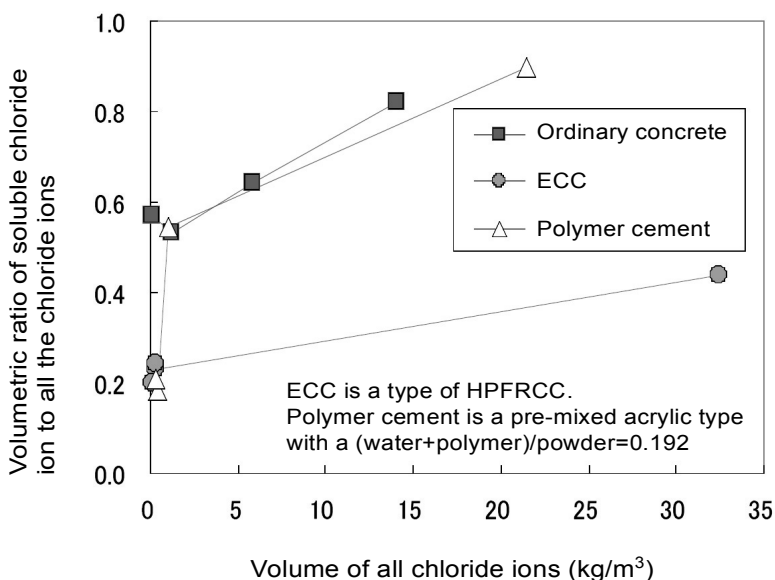


Fig. 9.3.2 A test result of amount of soluble salts against total chloride

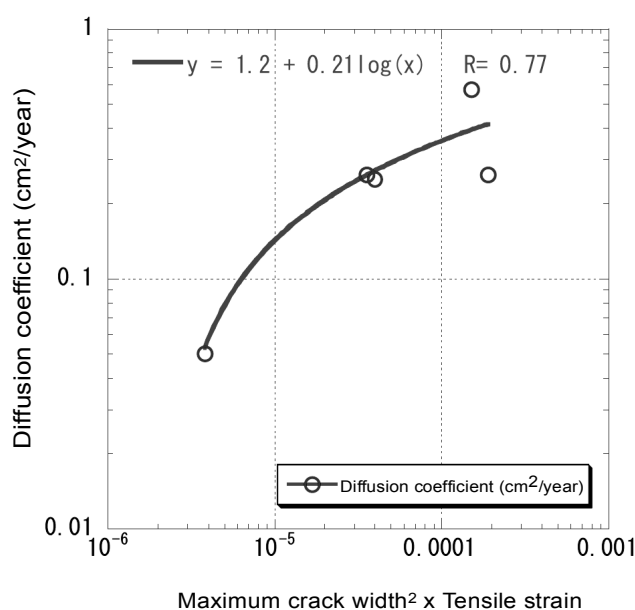


Fig. 9.3.3 An experimental value of chloride ion permeability of HPFRCC

into account the tensile strain and crack width that occur in HPFRCC in service. This is based on the design permeability of normal concrete that takes into account the crack width and crack interval in a structural member as specified in Standard Specifications for Concrete Structures –*Structural Performance Verification*. A high correlation can be found between tensile strain and crack interval of HPFRCC because the crack width exhibits small changes with changes in tensile strain below the ultimate tensile strain as shown in Fig. 9.3.1 while the induced tensile strain in HPFRCC is nearly equal to the value obtained by dividing the crack width by the crack interval. Thus it is possible in the determination of chloride ion permeability to replace the effects of crack width with that of tensile strain showing similar concept as used for normal concrete members.

Examples of experimental data for chloride ion permeability are shown in Fig. 9.3.3 (See appendix II-3 for details of the experiments), which is experimental data of “ECC Shot” as shown in appendix I-1. It is seen in this figure that chloride ion permeability of HPFRCC exhibits a relatively high correlation with the value of maximum crack width to the second power multiplied by tensile strain and can be expressed in the following formula. R in the figure shows the correlation coefficient.

$$D_d = D_k + D_0 \log(\varepsilon \cdot w^2) \quad (9.3.1)$$

Where D_d : design chloride ion permeability (cm²/year), D_k : materials parameter corresponding to chloride ion permeability of HPFRCC without cracks (cm²/year), D_0 : materials parameter representing the effect of crack and tensile strain on chloride ion permeability of HPFRCC, ε : design tensile strain estimated with section 7.2 of the “Recommendations”, and w : characteristic value of maximum crack width (mm).

(5) Experiments on the rate of steel bar corrosion due to chloride ion ingress for cracked HPFRCC and ordinary mortar are shown in Fig. 9.3.4 (See details for appendix II-4), where it is confirmed that HPFRCC shows a moderate general corrosion with a large anode/cathode area ratio due to the crack dispersibility while ordinary mortar shows local corrosion with a small anode/cathode area ratio. This is a result of the suppression of anodic and cathodic reactions at cracks due to HPFRCC's crack width control. (See Fig. 9.2.2) These experimental results allow the assumption that the corrosion rate may be suppressed by the corrosion cell pattern with a large anode/cathode area ratio when examining the corrosion rate of steel embedded in HPFRCC.

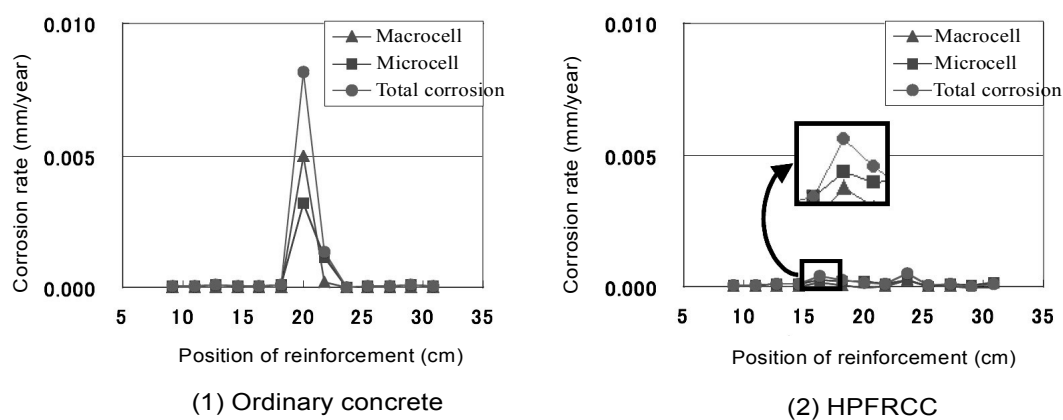


Fig. 9.3.4 Corrosion rate of cement based materials with a W/C of 0.3 subjected to chloride actions

9.4 Verification of freezing and thawing damages

- (1) HPFRCC structures shall be designed to maintain their required performance during freezing and thawing.
- (2) When HPFRCC is used as a cover component of a structure, the freeze/thaw resistance of HPFRCC can be examined without assuming the presence of cracks provided that the maximum crack width is less than that specified in section 7.6.2.
- (3) Verification of freeze/thaw resistance can be based on section 2.4 of Standard Specifications for Concrete Structures – “Materials and Construction”.

[Commentary] When subjected to freezing and thawing, HPFRCC restrains the crack width by the bridging effect of the reinforcing fiber. Thus, it has better resistance against freezing and thawing than the standard ready-mixed concrete.

(1) & (2) It is allowed to apply the method prescribed in Standard Specifications for Concrete Structures – “Materials and Construction” when verifying HPFRCC's resistance to freezing and thawing. According to the freezing and thawing test results in Fig. 9.4.1, no significant reduction

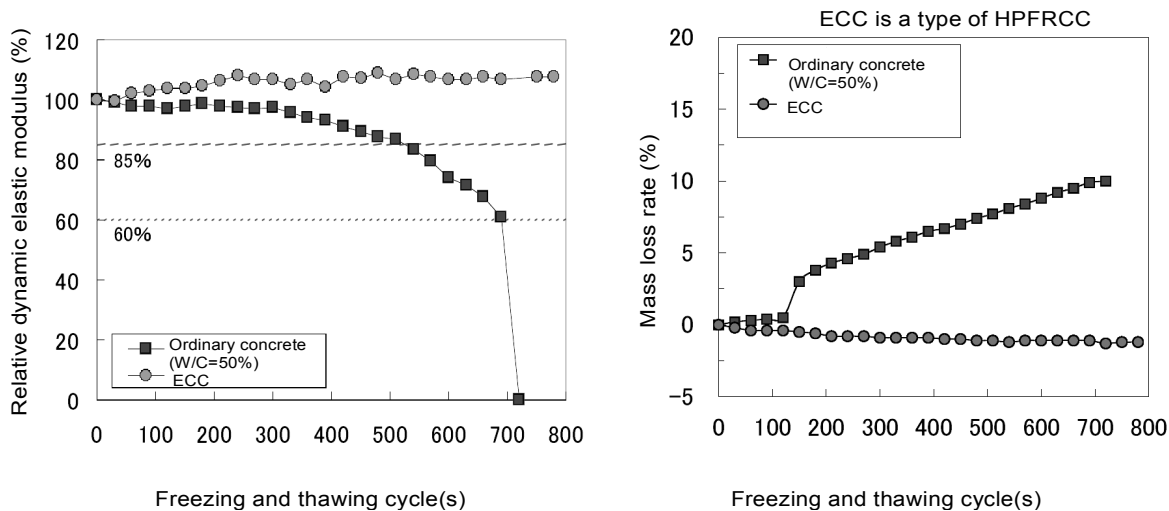


Fig.9.4.1 Resistance of HPFRCC to cyclic freezing and thawing

of relative dynamic elastic modulus and mass were found over 300 cycles.

Figure 9.4.2 shows an example of test results that confirmed HPFRCC's freezing and thawing resistance in cracked regions. Here, the test specimens were subjected to a load, both in air and in water, equivalent to approximately 1.5 times the cracking load (deflection of 0.2 mm at the center of the specimen) in the JSCE-G 552 bending test, and then subjected to the JIS A 1148 freezing and thawing test. In the freezing and thawing tests shown in Fig.9.4.2, no significant change was observed in the relative dynamic elastic modulus and mass loss rate. Also no significant difference was observed between flexural tests before and after freezing and thawing.

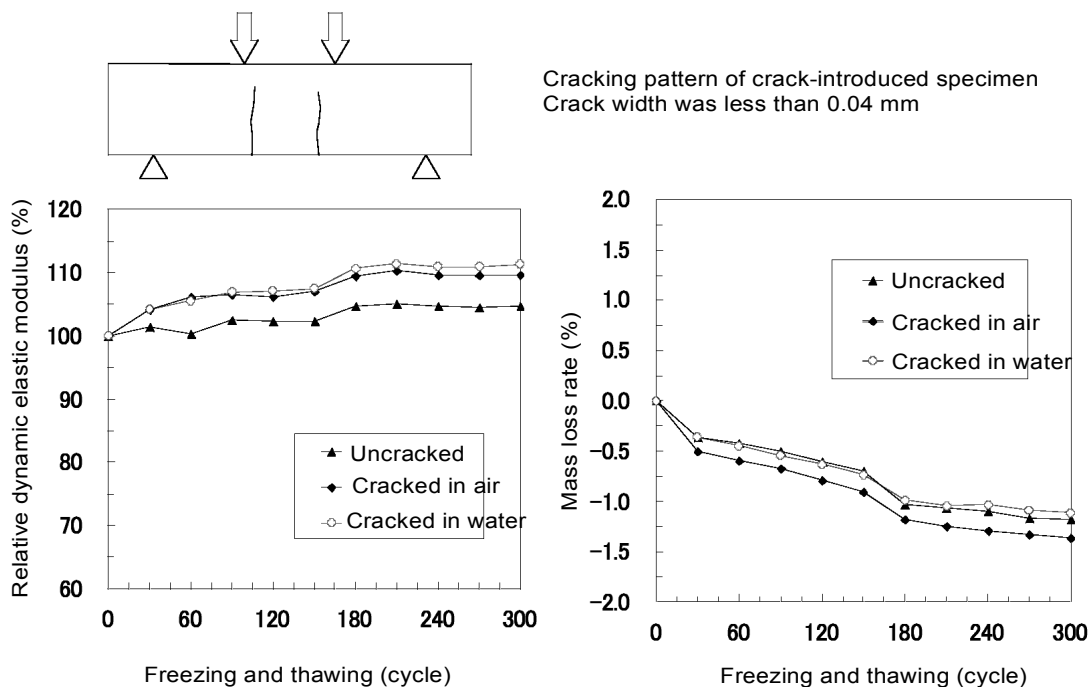


Fig.9.4.2 HPFRCC freezing and thawing tests on the cracked region

9.5 Verification of water-tightness

HPFRCC structures shall be verified for water-tightness to maintain their required performance by tests or other appropriate methods,

[Commentary] Because of the low water-binder ratio and the presence of additives, HPFRCC without cracks is more water-tight than the standard ready-mixed concrete. However for a cracked HPFRCC, water-tightness should be estimated appropriately by testing of water permeability, for instance, taking into account the required limit of crack width.

The water-tightness of HPFRCC can be verified by the method prescribed in section 6.4.8 “Verification for the coefficient of water permeability of concrete” of Standard Specifications for Concrete Structures – *Materials and Construction*.

9.6 Verification of resistance to chemical attacks

HPFRCC structures shall be verified for chemical attack resistance by tests or other appropriate methods not to lose their required performance by chemical attack.

[Commentary] HPFRCC’s resistance against chemical attack can be verified by the method prescribed in section 6.4.6 “Verification for resistance to chemical attack” of Standard Specifications for Concrete Structures – *Materials and Construction*.

9.7 Verification of alkali-aggregate reaction

- (1) HPFRCC structures shall not be damaged due to alkali-aggregate reactions.
- (2) If HPFRCC satisfies the required resistance against alkali-aggregate reactions, it can be deemed that performance of the structure will not be impaired by alkali-aggregate reactions.

[Commentary] HPFRCC’s resistance against alkali-aggregate reaction may be verified by the method prescribed in section 6.4.7 “Verification for resistance to alkali aggregate reaction” in Standard Specifications for Concrete Structures – *Materials and Construction*.

9.8 Verification of fire resistance

Refer to section 2.8 “Verification for fire resistance” in Standard Specifications for Concrete Structures – *Materials and Construction*.

[Commentary] While with reinforcing fiber, HPFRCC’s major component is mortar. Thus, its fire resistance is assumed to be similar to ordinary mortar or concrete. As shown in Table 3.6.1, it has a smaller thermal conductivity and tends to have a greater specific heat than concrete. Thus, the fire resistance of HPFRCC is almost equivalent to that of normal concrete. However, careful examination is needed for structures that should avoid a rapid strength reduction after fire due to the melting of fibers under fire exposure. (c.f. appendix II-6 “Fire Resistance of HPFRCC”).

Chapter 10 Concreting Work

10.1 General

- (1) For the placement of HPFRCC in principle, an execution plan shall be formulated and compiled with, based on the full understanding of material characteristics during placement and after hardening.
- (2) At the site, engineers or technicians who are fully informed about the concreting work shall be appointed.

[Commentary] (1) The provisions in this chapter are based on existing field experience, and may not be found applicable under other conditions. For example, if unusual member configurations or execution requirements are involved, the provisions here may become insufficient or difficult to apply. In such a case, an execution plan should be formulated to suit specific conditions, and to respect the purpose of the provisions to which this execution plan should be adhered.

(2) Engineers or technicians who are fully informed about HPFRCC work are defined as professional engineers specialized in concrete, JSCE accredited Civil Engineers (Professional Civil Engineers or higher qualification) specialized in concrete, Concrete Engineers and Chief Concrete Engineers authorized by JCI, or those who have more than equivalent expertise and experience, or those who have experience in HPFRCC work. It is essential to appoint such engineers on site for the proper controlling of the work in order to ensure the desired performance of completed HPFRCC structures.

10.2 Materials

10.2.1 Materials in general

Materials used in the placement of HPFRCC shall satisfy the performance required for HPFRCC.

[Commentary] The basic constituent materials of HPFRCC are: cement, aggregates, admixtures, water and reinforcing fiber. These materials should be mixed to create a composition that ensures various HPFRCC design values regarding the mechanical characteristics and resistance to environmental actions as specified in Chapter 3 of this “Recommendations” document.

10.2.2 Materials for matrix

- (1) The standard cement to be used for HPFRCC is portland cement specified in JIS R 5210 or fly-ash cement specified in JIS A 5213.
- (2) Aggregates for HPFRCC shall have a particle size that brings about fibers’ full reinforcing effect, in consideration of the diameter, length and other relevant factors of the reinforcing

fiber to be used. It shall also be confirmed that aggregates are resistant to alkali-silica reaction.

(3) Admixtures shall not cause damaging effects on HPFRCC.

[Commentary] (1) Portland cement is usually used for HPFRCC. In terms of fluidity and heat generation, moderate or low heat portland cement is suitable and has been widely applied in existing HPFRCC constructions. Because fly-ash is also used as an admixture, use of fly-ash cement conformable to JIS A 5213 may also be possible.

(2) The type and quality of aggregates sometimes greatly affects the resultant quality such as strength and tensile performance. Thus, selection of aggregates is extremely important for the production of HPFRCC. The required tensile performance cannot be achieved unless the particle size of aggregates is appropriate, with respect to diameter, length and aspect ratio of the reinforcing fiber. If aggregate particles have a low level of strength, the desired HPFRCC strength cannot be obtained, and the resistance to environmental actions may be impaired. The alkali reactivity of aggregates should be correctly evaluated, as the cementitious matrix incorporates a high cement content.

(3) Expansive additives may be used to compensate shrinkage deformations, as high volumes of cement and powder materials result in a high level of unit water content. It is prescribed that these admixtures should be used only after confirming that they will not have damaging effects on the setting and hardening, as well as strength and resistance to environmental actions of HPFRCC.

10.2.3 Water

As a standard, use non-recycled water prescribed in JSCE-B 101-1999 for mixing water. Avoid using water which might give any damaging effects on HPFRCC.

[Commentary] If mixing water contains impurities, it may give damaging effects on the workability, setting and hardening, strength development, and volume changes such as the shrinking and expanding of HPFRCC. Thus, non-recycled water prescribed in JSCE-B 101-1999 "Quality standard for concrete mixing water" is set as a standard, which should be used only after confirming it will not have any damaging effects.

10.2.4 Reinforcing fiber

Reinforcing fiber shall be used only after confirming the quality of HPFRCC that satisfies the designed performance of HPFRCC.

[Commentary] Selection of reinforcing fiber is extremely important, as it has significant impact on the tensile performance of HPFRCC. Because the balance between reinforcing fiber and matrices greatly affects the tensile performance of HPFRCC, it is necessary to

make a comprehensive judgment in view of the desired performance.

Polyvinyl alcohol fiber (PVA) and high-strength polyethylene fiber are common choices. The selection of reinforcing fiber needs to confirm with tests or reliable data that HPFRCC using the target fiber can meet the design values of mechanical properties and resistance to environmental actions as shown in Chapter 3 of this “Recommendations” document. Resistance to environmental actions of the fiber itself also needs to be confirmed as described in section 2.2 of this “Recommendations” document that it can sustain throughout the design service life of the structure. This confirmation may be accomplished with accelerated tests described in appendix II-7 “Long-Term Durability of Reinforcing Fibers Used in HPFRCC”.

10.2.5 Admixtures

Admixture for HPFRCC shall avoid anything that might have damaging effects on HPFRCC.

[Commentary] Because HPFRCC has a high volume of powder components, the use of air-entraining and high-range water-reducing agents is set as a standard to ensure desired fluidity. It should be confirmed by tests that the agent will result in the required performance of HPFRCC.

As long as strength is not impaired, it is advantageous to target an appropriate amount of entrained air for better resistance against freezing and thawing. In this regard, appropriate admixtures should be selected to achieve the desired performance and quality.

10.3 Mix proportions

10.3.1 General

HPFRCC manufactured according to the specified mix proportions shall be confirmed to satisfy designed material values and construction performances by appropriate methods.

[Commentary] The mix proportions of HPFRCC should be determined using the flowchart shown in Fig.10.3.1, based on in-depth studies on relating conditions such as the production and construction conditions of the structure and environment conditions. Note that the required hardened properties shown in this figure refer to the design values as described in Chapter 3 and appendix I-1 of the “Recommendations” document, and the required construction performances are mainly fluidity and workability represented as segregation resistance of materials that should be determined through verification specified in section 10.3.2 of this “Recommendations” document. An example of HPFRCC proportioning is shown in Table 10.3.1.

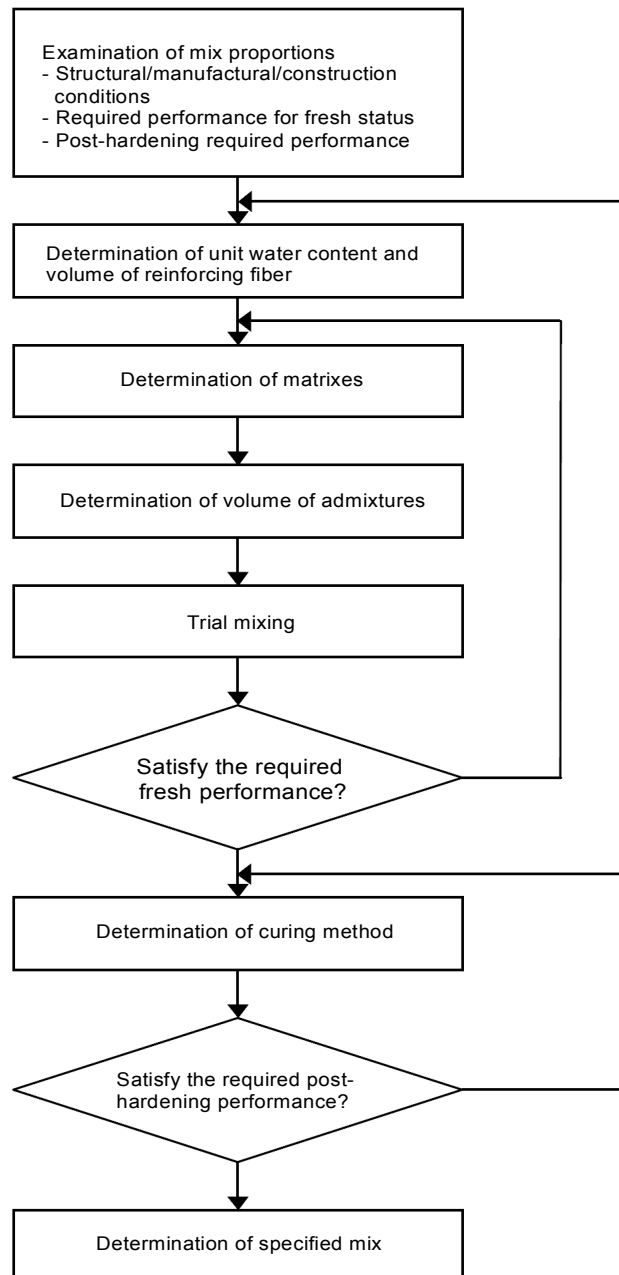


Fig.10.3.1 Mix proportion design flowchart

Table 10.3.1 Mix example

Flow value	Reinforcing fiber				Matrixes		
	Fiber type	Fiber diameter	Fiber length	Content	Water-to-binder ratio	Aggregate-binder volume ratio	Unit water content
(mm)	-	(mm)	(mm)	(Vol%)	(%)	(%)	(kg/m ³)
500	PVA	0.04	12	2.0	42.5	70	375

10.3.2 Workability

Workability of HPFRCC shall be based on appropriate indices according to construction conditions and construction methods and confirmed by tests whether it satisfies the required level.

[Commentary] Segregation resistance of materials necessary for dispersing large amounts of short fibers and fluidity that tends to be reduced subsequent to the addition of fibers need to be appropriately balanced in HPFRCC. Evaluation of the requirements may be executed for instance with the funnel flow test (JSCE-F512) and slump-flow test (JIS A 1150). Fluidity evaluation of high-fluidity concrete can be applied correspondingly to the evaluation of the workability of HPFRCC and funnel flow time and slump-flow can be set as 4 to 11 seconds and 500 to 600 mm respectively.

10.3.3 Verification of strength and strain

(1) In principle, the tensile yield strength of HPFRCC is verified by the following Equation (10.3.1):

$$\gamma_{typ} \frac{f_{ly}}{f_{typ}} \leq 1.0 \quad (10.3.1)$$

where,

f_{ly} : preset value of tensile yield strength of HPFRCC, generally set at characteristic value.

f_{typ} : measured value of HPFRCC's tensile yield strength,

γ_{typ} : safety factor for tensile strength f_{typ} , generally obtained by Equation (10.3.2).

$$\gamma_{typ} = \frac{1}{1 - \frac{1.645V_{ly}}{100}} \quad (10.3.2)$$

V_{ly} : coefficient of variation of HPFRCC's tensile yield strength,

(2) In principle, the ultimate tensile strain of HPFRCC is verified by Equation (12.3.3).

$$\gamma_{tup} \frac{\varepsilon_{tuk}}{\varepsilon_{tup}} \leq 1.0 \quad (10.3.3)$$

where,

ε_{tuk} : preset value of HPFRCC's ultimate tensile strain, generally set at characteristic value.

ε_{tup} : measured value of HPFRCC's ultimate tensile strain

γ_{tup} : safety factor for the elongation of ε_{tup} generally obtained by Equation (10.3.4).

$$\gamma_{tup} = \frac{1}{1 - \frac{1.645V_{tu}}{100}} \quad (10.3.4)$$

V_{tup} : coefficient of variation of HPFRCC's ultimate tensile strain (%)

(3) In principle, the compressive strength of HPFRCC is verified by Equation (10.3.5).

$$\gamma_{cp} \frac{f'_{ck}}{f'_{cp}} \leq 1.0 \quad (10.3.5)$$

where,

f'_{ck} : preset value of HPFRCC's compressive strength, generally set as the characteristic value.

f'_{cp} : measured value of HPFRCC's compressive strength

γ_{cp} : safety factor for compressive strength f'_{cp} , generally obtained by Equation (10.3.6).

$$\gamma_{cp} = \frac{1}{1 - \frac{1.645V_c}{100}} \quad (10.3.6)$$

V_c : coefficient of variation of HPFRCC's compressive strength (%)

(4) Other strength and strain values shall be verified in accordance with the verification of compressive strength, tensile yield strength, and ultimate tensile strain.

[Commentary] For matters other than those specified here, basically refer to section 6.4.2 "Verification for compressive strength" of Standard Specifications for Concrete Structures – *Materials and Construction*.

10.3.4 Representation of mix proportions

For the specified mix, the type and specifications of reinforcing fiber and unit mass of every material used shall clearly be stated.

[Commentary] Mix proportions are denoted by mass. In the specified mix, materials are denoted by mass per 1m^3 . An example of indicating the specified mix is shown in Table10.3.2.

Table 10.3.2 Indication of specified mix (Example)

Flow value (mm)	Reinforcing fiber				Unit content (kg/m ³)									
	Fiber type	Fiber diameter (mm)	Fiber length (mm)	Content (Vol%)	Cement	Water	Aggregates	Additive (1)	Additive (2)	Additive (3)	Fiber	Admixture (1)	Admixture (2)	Admixture (3)

10.4 Manufacture

10.4.1 Storage

(1) Fibers for use shall be stored in a way that protects it from dust, rainwater and other impurities.

(2) For materials other than those specified in this section, refer to 7.2.1 “Storage facilities” of Standard Specifications for Concrete Structures - *Materials and Construction*.

[Commentary] (1) Do not use fiber with impurities.

10.4.2 Batching

(1) For each material, apply batching methods and equipment that are suitable for HPFRCC production and ensure that batching errors in mass measurement are below the required level as shown in Table 10.4.1.

Table 10.4.1 Permissible batching errors

Material	Maximum batching error (%)
Water	1
Cement	1
Aggregate	3
Mineral admixture	2* ¹
Reinforcing fiber	1
Chemical admixture	3

*1) Maximum measuring error of blast-furnace slag shall be less than 1%

(2) Other than those specified here, refer to section 7.3 “Batching” of Standard Specifications for Concrete Structures - *Materials and Construction*.

[Commentary] Because the tensile property of HPFRCC is determined by the balance between matrix material and reinforcing fiber, it is recommended that maximum batching errors of reinforcing fiber be less than 1% as in that of water and cement.

10.4.3 Mixing

- (1) In principle, use mixers that are confirmed in advance by existing field data or tests to satisfy the design material properties and required performance for the manufacturing of HPFRCC.
- (2) HPFRCC shall be fully mixed until the materials become homogeneous, and the method and duration of mixing shall be determined appropriately based on existing field data or tests.
- (3) For HPFRCC, the maximum mixing amount per batch shall be determined appropriately by existing field data or tests, in consideration for the type, capacity and mixing efficiency of the mixer.
- (4) Mixers shall be washed if any other concrete products have been mixed before HPFRCC mixing.

[Commentary] (1) Due to higher viscosity than ordinary concrete, mixers with better mixing performance and efficiency should preferably be used for HPFRCC mixing. Take this into account in selecting a mixer, and perform trial mixing to confirm that the required performance is satisfied. The design material property refers to the design values as shown in Chapter 3 and appendix I-1 of this “Recommendations” document. The required performance for the manufacturing of HPFRCC refers to workability such as fluidity and resistance to segregation of materials and verification should be made according to 10.3.2 of this “Recommendations” document.

(2) The mixing procedures, such as the order of material charge, mixing volume and mixing time, should properly be determined to obtain the desired performance, because the performance of air-entraining and high-range water-reducing agent is affected by the order of charge, the mixer’s mixing performance and other relevant factors. Also note that the charging and mixing of reinforcing fiber should be properly determined according to the type of the reinforcing fiber. For example, consider the use of a blow machine to help reinforcing fiber disperse evenly.

(4) If the admixtures used for ordinary concrete and HPFRCC are incompatible, the desired quality may not be obtained, resulting in a reduction of flow value for example. Where there is contamination due to ordinary concrete, the contaminated portion may become a weak point in tensile performance, leading to a defect in the resultant member. Therefore, the mixer should always be washed with water when mixing HPFRCC after the mixing of ordinary concrete.

10.5 Transportation

HPFRCC shall be conveyed in a proper method, considering such factors as the fresh properties, the type and configuration of the member, conditions and climate of the site, volume to be executed, construction speed and safety of the work.

[Commentary] It is important that HPFRCC is used in a condition as near to the condition just after the mixing as possible. To do so, a proper conveying method should be selected, considering the construction and climatic conditions, in order to ensure there is little separation of materials and change in fresh properties. Where there is the risk of surface dehydration, the material should be conveyed after being given a proper treatment to avoid dehydration.

10.6 Placement

(1) In placing HPFRCC, the execution plan shall be formulated in consideration of the fact that the placement method affects the dispersion and orientation of reinforcing fiber.

(2) HPFRCC is basically placed by buckets or similar devices. A detailed plan for placement locations and methods shall be formulated in advance, in order to allow the placement work to be performed continuously until the whole section is completed.

(3) The placement speed shall be properly determined to suit the member configurations and steel arrangements based on existing field data or tests.

(4) Any locations that have overlaying placement on previously placed layer or merging may become weak points in HPFRCC, and thus shall be avoided where possible in principle. Shall such a placement procedure become inevitable, proper treatments shall be given, such as in the form of roiling with tamping rods.

(5) Where there is a construction joint, it shall be created by a test-proven proper method or procedure.

[Commentary] (2) When the HPFRCC placement work is suspended for a longer duration, the surface is dehydrated and produces a hard layer, where reinforcing fiber may lose their bridging effect. Therefore, it is prescribed that a detailed plan should be formulated in advance for placement locations and methods to allow the placement work to be performed continuously until whole one section is completed.

(3) It is prescribed that the placement speed of HPFRCC should be properly determined by existing field data or tests, in consideration for the mix proportions, member configurations and construction conditions. When an internal vibrator is used, its configurations and vibration time should also be determined properly, based on existing field data or tests.

(4) It is prescribed that any locations that have overlaying placement on a previously placed layer or merging should be avoided where possible in principle, because reinforcing fiber may lose its bridging effects there, which may create weak points in HPFRCC. If such a

placement procedure is inevitable, it is important to roil the locations with tamping rods or other relevant tools, as shown in Fig.10.6.1.

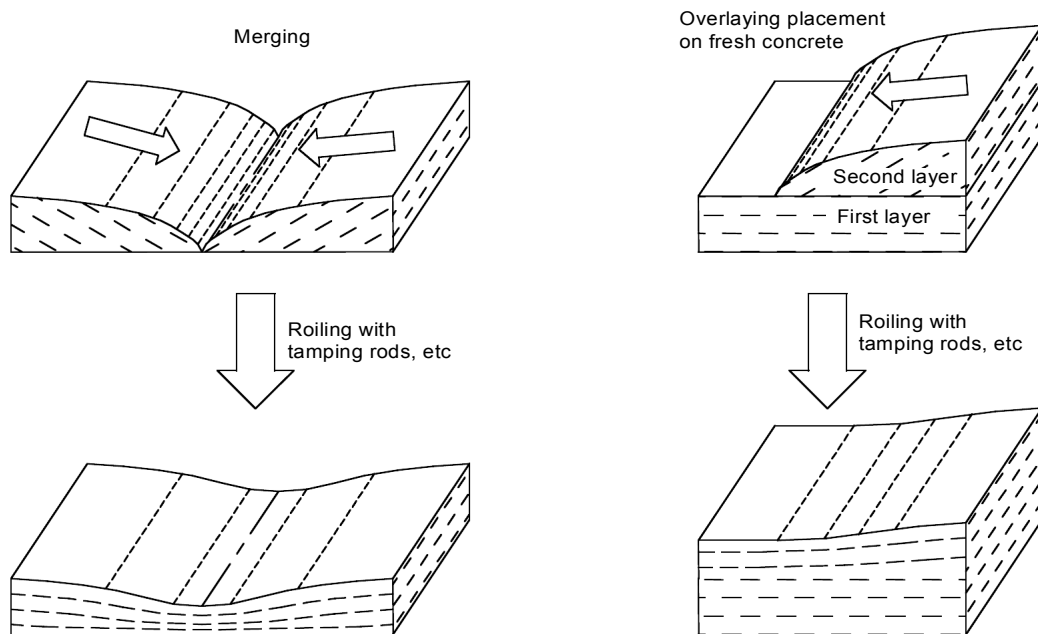


Fig.10.6.1 Examples of treatment for overlaying placement and merging

10.7 Finishing

The surface of HPFRCC shall be finished at an appropriate time in a proper method to achieve the desired configurations and dimensions and surface condition.

[Commentary] Due to high viscosity and little bleeding, HPFRCC is difficult to surface finish. It is important to prevent surface dehydration until the commencement of surface finish work, and to avoid performing surface finish work more than necessary. The precision of surface finish should be determined in view of later construction stages, and the work be done in a proper way that keeps such precision.

10.8 Curing

- (1) Initial curing shall be performed not to let HPFRCC dehydrate rapidly.
- (2) The curing method and period shall be determined in consideration of ambient temperatures during curing and be based on hardened property of HPFRCC.

[Commentary] (1) Initial curing should be performed in a method that ensures maintenance of temperature and moisture necessary for hardening and avoid any damaging effects. To obtain the desired performance, curing should be provided through such methods as sprinkling with water or covering with sheets or mats, based on existing field data or tests.

(2) As HPFRCC is more susceptible to environmental temperature than ordinary concrete, the curing method and period should be determined in consideration for the environmental temperature. Even when increasing the curing temperature out of the need for accelerating the strength development, it should be kept below 40°C in view of the long-term strength development.

10.9 Formwork and shoring

Refer to section 10.7 “Formwork and shoring” in Standard Specifications for Concrete Structures - *Materials and Construction*.

[Commentary] As HPFRCC members are usually thinner than those made of ordinary concrete, side pressure hardly becomes a problem in HPFRCC construction. Comply with Standard Specifications for Concrete Structures - *Materials and Construction* when using formwork and shoring to match specific construction conditions such as the size and configuration of the members.

10.10 Cold weather concreting

10.10.1 General

Except for those specified in this chapter, refer to section 10.9 “Cold weather concreting” of Standard Specifications for Concrete Structures - *Materials and Construction*.

[Commentary] If HPFRCC is exposed to the subzero temperatures during placement and hardening, unreacted free water in HPFRCC may freeze and expand, thereby causing initial frost damage. Once HPFRCC has suffered initial frost damage, its performance may become significantly poor even if proper curing is given afterwards. Also note that pre-hardening HPFRCC may suffer delay in the setting and hardening reactions when exposed to a temperature below 5°C if not frozen.

10.10.2 Materials and mix proportion

- (1) Use of heated water is designated as a standard method of keeping an adequate HPFRCC temperature during concreting in a low-temperature environment.
- (2) When heating powder materials, the heating temperature and method shall be determined after confirming by tests or other relevant methods that performance and quality of HPFRCC are not affected.
- (3) In principle, the mix proportions of HPFRCC in cold weather shall be adjusted by the amount of air-entraining and high-range water-reducing agent to achieve the desired consistency.

[Commentary] (1) & (2) Increasing the temperature of pre-mixed materials is one of the

solutions for keeping the adequate HPFRCC temperature during work in a low-temperature environment. When working with HPFRCC, it is effective to increase the mixing water temperature to 20 to 30 centigrade approximately. Where there is no choice but to heat powders, implement a heating method that has been confirmed not to affect quality.

(3) For HPFRCC, materials and their proportioning are determined to obtain the desired fresh and mechanical properties and resistance to environmental actions. Adjusting the consistency of HPFRCC with the level of unit water content may result in a failure of achieving the required performance. Thus, it is prescribed that the consistency should be adjusted by the amount of air-entraining and high-range water-reducing agent.

10.10.3 Transportation and placement

Refer to section 10.9.2 “Transportation within construction site and placing” of Standard Specifications for Concrete Structures - *Materials and Construction*.

10.10.4 Curing

(1) When using heat curing as the initial curing method, a rapid dehydration and localized heating of HPFRCC should be avoided.

(2) After heat curing, the temperature of HPFRCC should not decrease rapidly.

[Commentary] (1) & (2) The initial curing of HPFRCC should be applied until the desired strength is obtained, keeping the temperature and moisture necessary for hardening constant and avoiding any damaging effects. Heat curing is recommended as the cold-weather initial curing method for HPFRCC. Heat curing is to provide heat during curing while keeping moisture, which is adopted where sheet covering alone is insufficient for maintaining an appropriate temperature for hardening. The curing temperature of the heat curing should not exceed 40°C for the long-term strength development.

10.11 Hot weather concreting

10.11.1 General

Except for those methods specified in this chapter, refer to section 10.10 “Hot weather concreting” of Standard Specifications for Concrete Structures - *Materials and Construction*.

[Commentary] Due to a high level of unit cement content, viscosity and little bleeding, HPFRCC becomes more susceptible to the risk of consistency reductions during transportation, plastic shrinkage cracking and cold joint development when the temperature is high and water evaporation is rapidly accelerated. Therefore, during placement and immediately afterwards, the temperature of HPFRCC should be kept sufficiently low, preventing water evaporation by paying special attention to the material handling, mixing, conveying, placing and curing.

10.11.2 Materials and mix proportion

- (1) Use of cold water is recommended for maintenance of an adequate HPFRCC temperature during concreting in a high-temperature environment.
- (2) In principle, the mix proportions of HPFRCC in hot weather shall be adjusted by the dosage of chemical admixture such as air-entraining and high-range water-reducing agents to achieve the desired consistency.

[Commentary] (1) If certain facility conditions are satisfied, use of cold water of 10 to 20°C is effective for holding down the temperature of HPFRCC during work.

(2) For HPFRCC, constituent materials and their proportioning are determined to obtain the desired fresh and mechanical properties and resistance to environmental actions. Adjusting the consistency of HPFRCC with the level of unit water content may result in failure to achieve the required performance. Thus, it is prescribed that the consistency should be adjusted by the amount of air-entraining and high-range water-reducing agent.

10.11.3 Transportation and placement

- (1) In principle, refer to section 10.3.2 "Transport within construction site" of Standard Specifications for Concrete Structures - *Materials and Construction*.
- (2) Concreting of HPFRCC shall be done as quickly as possible; a duration of less than 1 hour between the completion of mixing and completion of concreting is set as a standard.
- (3) The temperature of HPFRCC during concreting shall be properly determined so as not to cause any damaging effects on the resultant structure, in consideration for the type of the structure, purpose, member's sectional dimensions, construction method and environmental conditions.

[Commentary] (2) Because the flow value of HPFRCC decreases over time, it becomes difficult to perform concreting if a long time has passed after mixing. According to existing field data, placement should be successful if placement is done within 1 hour after mixing. Because such quality change tends to increase with temperature, placement in a hot environment should preferably be done as soon as possible after mixing.

(3) The fluidity tends to decrease when the temperature of HPFRCC is high. Therefore, the temperature of HPFRCC should preferably be kept sufficiently low in accordance with the type and size of the structure, environmental conditions and curing method. However, the temperature effect is not significant at a mixing temperature less than 30°C, and for the range between 30 to 40°C, dosage of air-entraining and high-range water-reducing agent, introduction of retarding agent or acceleration of construction speed can assure the required quality of the HPFRCC hence the maximum mixing temperature of HPFRCC should be set at 40°C

10.11.4 Curing

(1) Curing shall begin immediately after placement of HPFRCC, protecting the surface from dehydration.

(2) For HPFRCC, the initial curing method and period shall be properly determined based on post-hardening physical property tests on specimens of appropriate age, in consideration of the environmental conditions, type and size of the structure, timing of incurring expected external force and construction plan.

[Commentary] (1) For HPFRCC, the post-placement initial curing should be given until the desired strength is obtained, keeping the temperature and moisture necessary for hardening and avoiding any damaging effects. Due to little bleeding, HPFRCC is susceptible to dehydration on the surface during the initial curing in a hot weather, and may incur plastic shrinkage cracking and other risks. In such a case, the surface should be protected from dehydration by an appropriate measure, such as by sprinkling water or sheet covering.

10.12 Inspection**10.12.1 General**

(1) Inspection at the placement shall be executed rationally and efficiently at each stage of the construction to confirm the required performance of HPFRCC and the completed structure.

(2) Inspection items other than specified in this section shall be based on chapter 11 "Inspection" of Standard Specifications for Concrete Structures – *Materials and Construction*.

[Commentary] (1) & (2) Inspection of placement of HPFRCC verifies whether the resulting HPFRCC and structures satisfy the designed performance requirements. The goal of a construction is to assure the design performance of the structures, which should be directly inspected in the completed structures. However, inspection items of the completed structure may be currently limited for instance to its external appearance or position/dimension of components. Thus the inspection is actually executed at each stage of the construction and needs to confirm by synthesis of inspections that the required performances of the structure are satisfied. This section only deals with inspection items that are different from those of the normal concrete, and items without description here should refer to the Chapter 11 "Inspection" of Standard Specifications for Concrete Structures – *Materials and Construction*.

10.12.2 Inspection for acceptance of constituent materials of HPFRCC

(1) Materials composing the matrix such as cement, aggregate and admixture are inspected by the manufacturers' test grading reports. Where necessary, additional tests are performed in accordance with relevant JIS or JSCE standards.

(2) Mixing water is in principle inspected in accordance with section 11.3.3 "Mixing water" of Standard Specification for Concrete Structures - *Materials and Construction*.

(3) Admixtures are inspected by the manufacturers' test grading reports. Where necessary, additional tests are performed in accordance with relevant JIS or other standards.

(4) Reinforcing fiber is inspected by the manufacturer's test grading report. Where necessary, additional tests are performed in accordance with relevant JIS or other standards.

10.12.3 Inspection of production

Refer to section 11.4 "Inspection of production" of Standard Specifications for Concrete Structures - *Materials and Construction*.

10.12.4 Inspection for acceptance of HPFRCC

(1) In inspection for acceptance of HPFRCC, appropriate inspection items, methods, timing and frequency shall be determined based on the required performance and the size and importance of the structure.

(2) If HPFRCC is rejected by inspection, proper arrangements shall be made to settle the matter by consultations between the delivering/receiving parties.

[Commentary] (1) The required performance of construction for HPFRCC varies with the construction method. As the required fresh properties also significantly vary when a special construction method is applied, it is necessary to select a method of appropriately evaluating the fluidity and resistance to segregation of materials. An example of HPFRCC inspection is shown in Table 10.12.1.

Due to its high viscosity, HPFRCC is susceptible to inclusion of entrapped air. If an excessive volume of air is entrapped, the risk of causing damaging effects on the required strength, resistance to environmental actions and surface aesthetics increases. For this reason, the bulk density has been included in the list of inspection items.

For HPFRCC compressive strength tests, a cylinder of 100mm in diameter and 200mm in height or 50mm in diameter and 100mm in height is set as the standard specimen. The size of a specimen is primarily determined according to the diameter of aggregates and length of reinforcing fiber.

The tensile strength characteristics of HPFRCC are tensile yield strength and ultimate tensile strain, or other relevant indices tested by uniaxial tensile test.

10.12.5 Inspection for acceptance of reinforcement

In principle, refer to section 11.6 “Inspection for acceptance of reinforcement at delivery” of Standard Specifications for Concrete Structures - *Materials and Construction*.

10.12.6 Inspection of construction

In principle, refer to section 11.7 “Inspection of construction” of Standard Specifications for Concrete Structures - *Materials and Construction*.

10.12.7 Inspection of structures

In principle, refer to section 11.8 “Inspection of structures” of Standard Specifications for Concrete Structures - *Materials and Construction*.

Table 10.12.1 Example of HPFRCC inspection items

Item	Inspection method	Period • Frequency	Criteria
Mix proportions	Measured value of each material	Every batching	To be within an allowable error range
Fresh status	Visual inspection or examination by hands by the engineer in charge or some other engineer who has the equivalent expertise	During work where necessary	Good workability, homogeneous and stable quality
Fluidity	Flow value JIS A 1150	Upon commencement of work	To satisfy the conditions required by the construction method
Segregation resistance	V-funnel flow time	Upon extraction of specimens	
Bulk density	JIS A 1116	When any change of quality is observed	
Mixing temperature	Temperature reading		
Compressive strength	JIS A 1108	Once a day, or once every 20 m ³ to 150 m ³ , in accordance with the importance of the structure and size of the project	To be able to predict, with an appropriate producer's risk level, the fact that the percentage of falling below the design standard value is 5% or less
Tensile yield strength	Uniaxial tensile test (Testing method 2)		
Ultimate tensile strain			
Maximum crack width	HPFRCC crack width test method (Testing method 3 & 4)		

Chapter 11 Shotcrete

11.1 General

- (1) In principle, HPFRCC shotcrete shall be produced in accordance with an execution plan that is formulated based on a full understanding of the characteristics of HPFRCC during work and after hardening.
- (2) At the site, engineers or technicians who are fully informed about the spraying of HPFRCC shall be appointed.
- (3) Items other than specified in this section shall be based on Part 3 "*Repair and Strengthening*" of *Recommendations for Shotcreting* (Draft).

[Commentary] (1) The provisions in this chapter are based on existing field experience. If unusual execution requirements are involved, an execution plan shall be formulated to suit specific conditions, and respect the purpose of the provisions to which this execution plan should be adhered.

(2) Engineers or technicians who are fully informed about the shotcreting of HPFRCC refer to the engineers defined in Chapter 10, as well as those who have experienced the spraying of HPFRCC. It is essential to appoint such engineers on site for proper controlling of the work in order to ensure the desired performance of sprayed HPFRCC.

11.2 Materials

11.2.1 Materials in general

Constituent materials of HPFRCC shall be confirmed in quality to satisfy the design material properties of the resulting HPFRCC.

[Commentary] The basic constituent materials of shotcrete HPFRCC are: cement, aggregates, admixtures, water, reinforcing fiber, and additives. These materials should be confirmed by tests or reliable data to satisfy the design material properties of the resulting HPFRCC such as mechanical properties specified in Chapter 3 and Appendix I-1 of this "Recommendations" document. In the shotcreting, HPFRCC is pumped and sprayed by compressed air through the head of the spraying nozzle. Given this, workability should be fully considered in selecting the materials.

The production of a HPFRCC spraying material takes either of the following two procedures: to carefully select and procure each material and mix them; or to use a premixed product, in which reinforcing fiber and matrices have been carefully selected and mixed in advance. Use of a premixed product is set as the standard, as it saves labor in proportioning and batching, as well as enabling the production of sprayed HPFRCC with stable quality.

11.2.2 Materials for matrix

(1) It is set as the standard that matrix materials for HPFRCC shall be of the premixed type capable of satisfying the design material values of the resulting HPFRCC.

[Commentary] Because HPFRCC shotcreting is executed on site, the use of a premixed product is set as the standard, as it allows easy batching and mixing, as well as the production of HPFRCC shotcrete with stable quality. When using a premixed product, it should be confirmed in advance that it can satisfy the design material properties of the resulting HPFRCC such as mechanical properties specified in Chapter 3 and appendix I-1 of the “Recommendations”, and that it can be provided with stable quality within the manufacturing lead time.

If there is no choice but to select each matrix materials individually (“non-premixed type”), refer to 10.2.2 of this “Recommendations” document.

11.2.3 Water

Refer to section 10.2.3 “Water” of this “Recommendations” document.

11.2.4 Reinforcing fiber

Refer to section 10.2.4 “Reinforcing fibers” of this “Recommendations” document.

11.2.5 Admixtures

Refer to section 10.2.5 “Admixtures” of this “Recommendations” document.

11.2.6 Anchoring

(1) Installation of anchors is set as the standard in the spraying of HPFRCC for the purpose of preventing delamination of the sprayed HPFRCC.

(2) The quality, size and installation intervals of anchors shall be determined based on thorough examination through tests and existing field data. Anchors shall be made of highly durable materials.

[Commentary] (1) It has been confirmed by past tests that the integrity of sprayed HPFRCC and existing concrete can be fully achieved by adhesion. However, because sprayed HPFRCC is resistant against tensile force even when cracked, there is the risk of flaking at the edges induced by drying shrinkage. In this respect, installation of anchors is set as the standard for the purpose of preventing flaking and delamination at the edges.

(2) As members made of sprayed HPFRCC are generally thinner than usual, it is often difficult to provide enough concrete cover for anchors. For this reason, it is prescribed that anchors made of highly durable materials, such as stainless anchors, should be selected.

11.3 Mix proportions

11.3.1 General

Mix proportions of shotcrete HPFRCC material shall be designed to satisfy the design material properties of the resulting HPFRCC and be confirmed by appropriate methods to have required construction performance.

[Commentary] The proportioning of shotcrete HPFRCC materials should be determined using the flowchart shown in Fig.11.3.1, where the “required hardened properties” account for design material values specified in Chapter 3 and appendix I-1 of this “Recommendations” document. The “required fresh performance” refers to workability and pumpability as represented in terms of fluidity and resistance to segregation of materials that should be verified referring to section 11.3.2 of this “Recommendations” document. An example of mix proportions for a HPFRCC spraying material is shown in Table11.3.1.

Table11.3.1 Mix example

Flow value (mm)	Reinforcing fiber				Matrixes		
	Fiber type	Fiber diameter (mm)	Fiber length (mm)	Content (Vol%)	Water-to-binder ratio (%)	Aggregate-binder ratio (%)	Unit water content (kg/m ³)
375	PVA	0.04	12	2.0	32	45.0	360

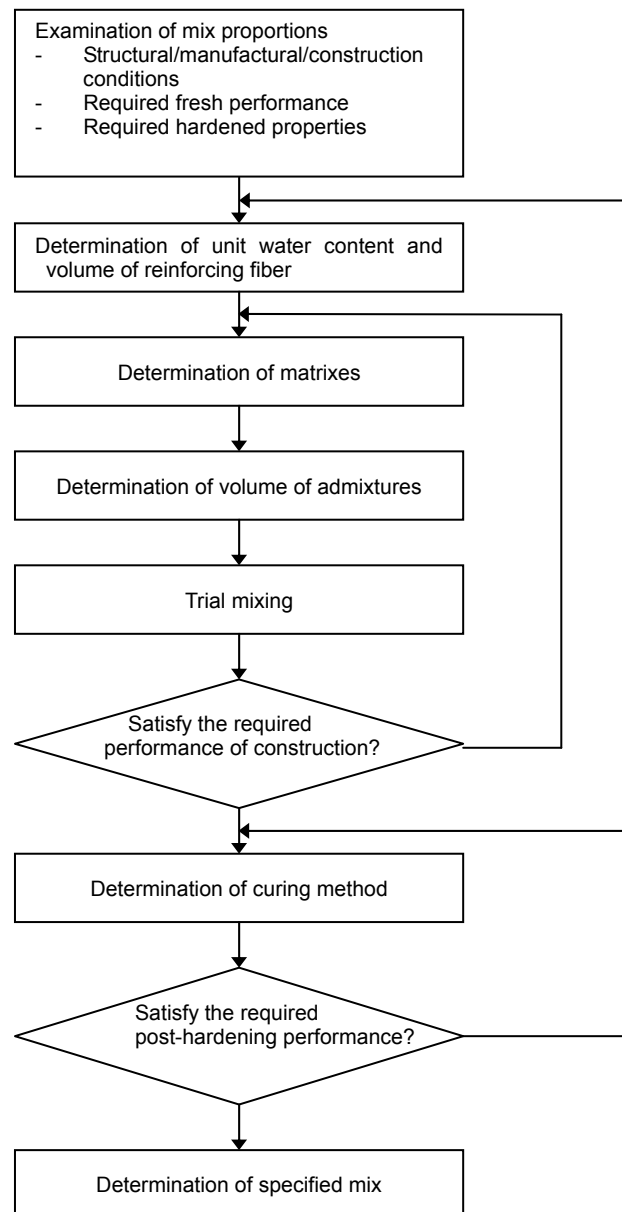


Fig.11.3.1 Mix proportion design flowchart

11.3.2 Workability

(1) The workability of HPFRCC shall be confirmed by tests whether it satisfies the required levels determining appropriate indices according to the construction conditions and methods.

[Commentary] Workability of HPFRCC needs to be determined taking into account bond strength after spraying, the spraying direction and pumpability. An excessively large flow value may cause damaging effects on the setting and hardening process or strength development and cause sagging before hardening, thereby resulting in a failure in achieving the desired quality. As an index for evaluating workability, the flow value for instance from slump flow testing (JIS A 1150)

can be adopted. When evaluating the workability of ECC shown in appendix I-1 with this index, it is recommended the flow value be set at below 450mm.

11.3.3 Verification of strength and strain

For verification of strength and strain of sprayed HPFRCC, refer to section 10.3.3 “Verification of strength and strain” in Chapter 10 “Concreting Work” of this “Recommendations” document.

11.3.4 Representation of mix proportions

For the specified mix, the type, specifications and content of reinforcing fiber and every material used shall clearly be stated.

[Commentary] Mix proportions are denoted by mass. In the specified mix, they are denoted by the unit content of material per 1m^3 . An example of indicating the specified mix is shown in Table 11.3.2.

Table 11.3.2 Indication of specified mix when using premixed product (Example)

Flow value— (mm)	Reinforcing fiber				Unit content (kg/m^3)				
	Fiber type	Fiber diameter (mm)	Fiber length (mm)	Content (Vol%)	Premixed product	Water	Admixture (1)	Admixture (2)	Admixture (3)

11.4 Manufacturing

11.4.1 Storage

(1) Premixed products shall be stored in a way that protects them from rainwater and other impurities. Hence the storage place shall be free from direct sunlight, rainwater and moisture, and the products shall be covered with plastic sheets and placed on pallets, etc. to be away from the floor.

(2) Except for those specified here, refer to section 7.2.1 “Storage facilities” of *Standard Specifications for Concrete Structures - Materials and Construction*.

11.4.2 Batching

For methods and tools for batching, refer to section 10.4.2 of this “Recommendations” document.

11.4.3 Mixing

For mixing, refer to section 10.4.3 of this “Recommendations” document.

11.5 Preparation of concrete surface

Surface preparation such as cleaning, blustering and coating with primers shall be applied to the existing structures to achieve the design bond strength of the sprayed HPFRCC with appropriate materials and methods.

[Commentary] HPFRCC can be applied for various purposes, such as the patching repair and surface coating for deteriorated concrete and bottom-overlay retrofitting for concrete slabs. When applying shotcrete HPFRCC, the existing structure should be given proper pretreatment to achieve the integrity of the existing concrete. For practice, refer to 6.5 “Preparation of concrete surface” of Part 3 “*Repair and Strengthening*” of *Recommendations for Shotcreting* (Draft). These treatments should be confirmed by existing field data and tests in advance that they help achieve the desired bond strength after the spraying of HPFRCC.

11.6 Transportation

HPFRCC spraying materials shall be properly conveyed in consideration of fresh properties, type and configurations of the member, site conditions, climates during work, spraying volume, spraying speed and safety of the work.

[Commentary] It is important to ensure that HPFRCC is sprayed in a state as near to the state immediately after mixing as possible. HPFRCC is generally pumped to the head of the spraying nozzle. The distance and height of pumping should properly be determined in consideration of climatic conditions, after confirming by tests or existing field data that they will not incur any material segregation or change of fresh properties.

11.7 Spraying

- (1) HPFRCC shotcrete shall be made according to a construction system that has been confirmed in advance and can assure the prescribed design material values and is suitable for the smooth shotcreting of HPFRCC.
- (2) The thickness of continuous spraying shall be properly determined according to the specific conditions.
- (3) When spraying in summer or winter, proper treatment shall be necessary to prevent the spraying material from deterioration due to thermal stresses.

[Commentary] (1) Unless being performed according to a proper construction system, it is difficult to obtain the desired performance, such as tensile performance for the resultant sprayed

HPFRCC. Therefore, it is prescribed that HPFRCC should be sprayed according to a construction system that has been confirmed in advance that it is suitable for the spraying of HPFRCC. The prescribed design material value refers to design values described in Chapter 3 and appendix I-1 of this “Recommendations” document.

Figure 11.7.1 outlines a spraying system, which has a field record of HPFRCC spraying. The mixed material is pumped by a squeeze type mortar pump to a spraying gun and sprayed onto the working surface with compressed air. Note that existing field data show that this system allows the horizontal and vertical pumping of 60m and 20m, respectively, and a production and spraying speed of approximately 300L/h.

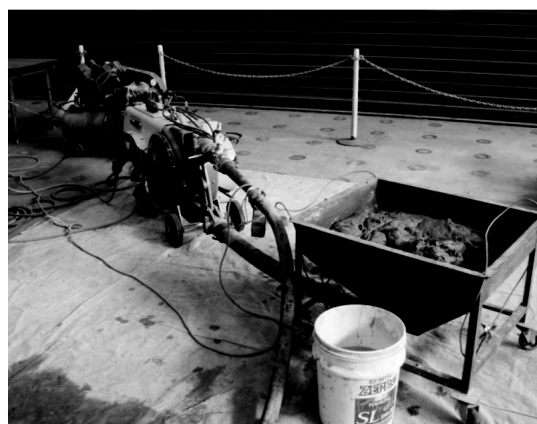
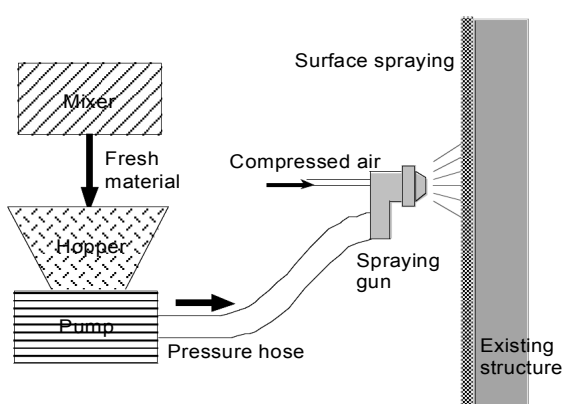


Fig.11.7.1 Spraying system example

Photo 11.7.1 Pump example

(2) When HPFRCC is sprayed for a thick region at once, there is the risk of flaking immediately after spraying and delamination after hardening. Therefore, the thickness of continuous spraying should be properly determined by tests and existing field data so as not to incur any undesired phenomena. When spraying in two or more layers, a sufficient number of spraying intervals should be applied to prevent flaking of the previously sprayed layer. In such a case, proper intervals of overlay spraying, layered spraying, and primer application should be used and a proper application method that is confirmed by tests or field data should be adopted to prevent the interlayer adhesion from deterioration.

(3) During summer, a HPFRCC spraying material sets quickly and its usable time becomes short. In winter, on the other hand, the material sets slowly and affects efficiency. Therefore, in summer and in winter, a proper treatment should be taken so as not to let the performance of HPFRCC spray deteriorate by thermal stresses.

11.8 Finishing

Finishing work shall be properly performed to obtain the desired section and a smooth texture upon completion.

[Commentary] (1) Upon completion of spraying, confirm that the material does not flake by finishing work. Finish surfaces with trowels to achieve a smooth texture. When doing this, fresh HPFRCC from a spraying gun may be applied with trowels to correct unevenness. In such a case, pay attention so that the volume of trowel application will not become large.

(2) Thickness is controlled such as with leveling cords during work, so that the sprayed HPFRCC has a prescribed thickness. Note that detailed controlling methods should be determined for individual project by prior consultations as they vary according to the location and purpose of the work.

11.9 Curing

(1) Initial curing to avoid rapid dehydration using curing compounds is set as the standard for shotcrete HPFRCC.

(2) The curing compound shall be confirmed to enable the resulting shotcrete HPFRCC to achieve the design values.

[Commentary] Curing of sprayed HPFRCC is executed for the purpose of preventing dehydration after work, and is important in maintaining the desired performance of sprayed HPFRCC that is often applied in a thin layer. If sprayed HPFRCC is not properly cured, there is a risk of losing desired performance because dehydration makes the amount of water insufficient for hydration. However, it is difficult to use mats to cure HPFRCC sprayed on walls or the bottom of beams and slabs. Thus, it is set as a standard that curing compounds are provided by spraying a primer or other relevant materials with blowguns in a prescribed amount, as soon as possible after the shotdretting. If any other curing methods are taken, their applicability of assuring the prescribed design material values to sprayed HPFRCC should be confirmed in advance. During summer and winter, proper treatment should be applied according to section 10.10.4 and 10.11.4 of this “Recommendations” document.

11.10 Inspection

11.10.1 General

(1) Inspection of shotcrete construction shall be executed rationally and efficiently at each stage of the construction to confirm the required performance of HPFRCC and of the completed structure.

(2) Inspection items other than specified in this section shall be based on Chapter 7 “Inspection” of Part 3 “*Repair and Strengthening*” of *Recommendations for Shotcreting* (Draft).

[Commentary] Inspection of shotcrete construction verifies whether the resulting HPFRCC and structures satisfy the design performance requirements. The goal of a construction using HPFRCC is to assure the design performance of the structures, which should be directly

inspected using the completed structures. However, inspection items of the completed structure may be currently limited for instance to its external appearance or position/dimension of components. Thus the inspection is actually executed at each stage of the construction and needs to confirm by synthesis of inspections that the required performances of the structure are satisfied. This section only deals with inspection items that are different from those of the normal concrete, and items without description here should refer to Chapter 7 “Inspection” of Part 3 “*Repair and Strengthening*” of *Recommendations for Shotcreting* (Draft).

11.10.2 Inspection for acceptance of constituent materials of HPFRCC

- (1) Materials composing the matrix such as cement, aggregate and admixture are inspected by the manufacturers’ test grading reports. Where necessary, tests are performed in accordance with relevant JIS or JSCE standards.
- (2) Mixing water is in principle inspected in accordance with section 11.3.3 “Mixing water” of Standard Specifications for Concrete Structures - *Materials and Construction*.
- (3) Admixtures are inspected by the manufacturers’ test grading reports. Where necessary, additional tests are performed in accordance with relevant JIS or other standards.
- (4) Reinforcing fiber is inspected by the manufacturer’s test grading report. Where necessary, tests are performed in accordance with relevant JIS or other standards.
- (5) Incoming inspection of primer and curing compound shall be performed by visually confirming the invoice or label indications that they are the desired products.
- (6) Incoming inspection of anchors shall be performed by visually confirming the invoice or label indications that they are the desired products.

11.10.3 Inspection of construction equipment

Refer to section 7.4 “Inspection of equipment” of Part 3 “*Repair and Strengthening*” of *Recommendations for Shotcreting* (Draft).

11.10.4 Inspection during manufacturing

- (1) Inspection of HPFRCC during manufacturing shall be determined in terms of the inspection item, method, period and frequency according to the required performance, size and importance of structures.
- (2) For items other than that described in this section, refer to section 7.5 “Inspection of production process” Part 3 “*Repair and Strengthening*” of *Recommendations for Shotcreting* (Draft).

[Commentary] (1) The required consistency of HPFRCC varies with the direction and thickness of spraying and construction conditions such as work environment. It is necessary to select a method that allows evaluation of the desired quality. Under common conditions, it is recommended that the flow value of HPFRCC shotcrete be set at below 450mm. An example of

inspecting HPFRCC shotcrete is shown in Table 10.11.1. In spraying HPFRCC, an appropriate amount of entrained air improves pumping efficiency and workability as it reduces clogging of material at the tip of the spraying nozzle. For this reason, the bulk density has been included in the list of inspection items.

Table 11.10.1 Inspection of HPFRCC during manufacturing

Item	Inspection method	Period•Frequency	Criteria
Mix proportions	Measured value of each material	Every batching	To be within an allowable error range
Fresh status	Visual inspection or examination by hands by the engineer in charge or some other engineer who has the equivalent expertise	During work where necessary	Good workability, homogeneous and stable quality
Consistency	Flow value JIS A 1150	Upon commencement of work	To satisfy the conditions required by the construction method
Bulk density	JIS A 1116	Upon extraction of specimens	
Temperature of mixed concrete	Temperature reading	When any change of quality is observed (on unsprayed samples)	

11.10.5 Inspection of shotcrete placement

In principle, refer to section 7.6 “Inspection of shotcrete placement” of Part 3 “*Repair and Strengthening*” of *Recommendations for Shotcreting* (Draft).

11.10.6 Inspection of reinforcement assembly

In principle, refer to section 7.7 “Inspection of reinforcement assembly ” of Part 3 “*Repair and Strengthening*” of *Recommendations for Shotcreting* (Draft).

11.10.7 Inspection of sprayed HPFRCC

(1) When inspecting HPFRCC after shotcreting, appropriate items, methods and timing of inspection shall be determined according to the required performance, size and importance of the structure

(2) Inspection items other than specified in this section shall be based on section 7.8 “Inspection of in-place shotcreting” of Part 3 “*Repair and Strengthening*” of *Recommendations for Shotcreting* (Draft).

[Commentary] An example of inspection items for HPFRCC after shotcrete construction is shown in Table 11.10.2. The inspection items here address the material properties. Other inspection items such as the completed part inspection or cover thickness inspection should be based on section 7.8 “Inspection of in-place shotcreting” of Part 3 “*Repair and Strengthening*” of the *Recommendations for Shotcreting* (Draft). Because HPFRCC is preferably used at its tensile

performance characterized by the excellent crack dispersibility, tensile yield strength and ultimate tensile strain, these characteristics need to be tested according to the testing method 1 to 4 specified in “Testing and evaluation method” of this “Recommendations” document.

Considering that specimens for testing the compressive strength of sprayed HPFRCC are made by spraying, a cylinder of 100mm diameter and 200mm high is set as the standard in view of the efficiency. Sprayed HPFRCC is required to have integrity with existing concrete. If sufficient integrity is not achieved, expected benefits of using HPFRCC are not brought about and there is a risk of flaking or other defects that may influence the third persons. In this regard, bonding strength has been included in the list of inspection items.

Table 11.10.2 Inspection of shotcrete HPFRCC construction

Item	Inspection method	Period•Frequency	Criteria
Compressive strength	JIS A 1108	More than once per project Upon commencement of work, and when any change of quality is observed	To be able to predict, with an appropriate producer’s risk level, the fact that the percentage of falling below the design standard value is 5% or less
Tensile yield strength	Uniaxial tensile test (Testing method 2)		
Ultimate tensile strain			
Maximum crack width	HPFRCC crack width test method (Testing method 3 & 4)		
Bonding strength	Bonding strength tests developed by the Building Research Institute		

11.10.8 Inspection of structures after installation of HPFRCC

In principle, refer to section 7.9 “Inspection of structure repaired and strengthened with shotcrete” of Part 3 “Repair and Strengthening” of Recommendations for Shotcreting (Draft).

Testing Method 1: Preparation of Specimens for Strength Tests

1.1 Scope

This standard prescribes the method of producing mold-cast specimens for compressive strength and uniaxial tension tests on High Performance Fiber Reinforced Cement Composites with Multiple Fine Cracks (HPFRCC).

1.2 Referenced standards

The following standards form a part of this standard through references herein. The latest versions of the standards should be applied for this purpose.

JSCE-F505	Method of making mortar in the laboratory (in Japanese)
JSCE-F506	Method of making mortar or cement paste cylindrical specimens for compressive strength tests (in Japanese)
JSCE-F551	Method of making steel fiber reinforced concrete in the laboratory (in Japanese)
JIS A 1115	Method of sampling fresh concrete
JIS A 1132	Method of making and curing concrete specimens
JIS A 1138	Method of making test samples of concrete in the laboratory

1.3 HPFRCC samples

HPFRCC should be sampled as follows.

- When producing HPFRCC specimens in the laboratory, provisions of JIS A 1138, JSCE-F505 or JSCE-F551 should be applied to suit the HPFRCC material to be tested.
- JIS A 1115 should be followed when sampling HPFRCC from mixers, hoppers, concrete bucket or placed concrete.
- Sprayed HPFRCC should be sampled on sites or from sprayed HPFRCC on form panels, etc., or directly from the same material as those adopted in the spray.

1.4 Number of specimens

The number of specimens should be as follows.

- Three or more for compressive tests, and
- Five or more for direct uniaxial tension tests.

1.5 Specimens for compression tests

1.5.1 Dimensions of specimens

Specimens should be cylindrical having a height twice the size of the diameter. The diameter should be determined pursuant to JIS A 1132 or JSCE-F 506.

1.5.2 Specimen production apparatus

Specimens should be produced as follows.

- a) Molds should be cylindrical, made of a non-water-absorbing material resistant to cement such as metal or plastic.
- b) Molds should be free from deformation or water leakage during production of specimens,
- c) Molds should be designed to ensure the precision required for the specimen to be produced.
- d) Appropriate form release agent or mineral oil may be applied on the internal surfaces of the molds.
- e) When compacting with a mallet, the mallet should have weight and dimensions sufficient for ensuring adequate compaction for the target HPFRCC.
- f) When compacting with a vibration table, the table should have performance sufficient for ensuring adequate compaction for the target HPFRCC.
- g) The capping plate should be a polished glass or a polished steel plate thicker than 6mm having a size at least 25mm greater than the diameter of the mold.

1.5.3 Production of specimens

1.5.3.1 Using a mallet

Specimens should be produced in the same procedures (e.g. placement and spraying methods) as in the actual work, and the use of an internal vibrator is prohibited. During placement, the material should be filled into the mold without pausing to minimize the production of air voids. To compact the material filled, the sides of the mold should be tapped with a mallet to reduce air voids and create a smooth surface.

1.5.3.2 Using a vibration table

Specimens should be produced in the same procedure (e.g. placement and spraying methods) as applied in the actual work, and the use of an internal vibrator is prohibited. During placement, the material should be filled into the mold without pausing to minimize the formation of air voids. To reduce air voids, the mold should be stuck tightly to the vibration table to apply vibration for compaction. The duration of compaction should be determined according to the properties of the target HPFRCC and to the performance of vibrator to ensure adequate compaction. Care should be taken for the duration of compaction not to cause materials segregation.

1.5.3.3 Compaction at the top layer

The material should be filled to the top rim of the mold allowing the top face of HPFRCC after compaction becomes slightly below the top rim. Where the end face of the specimen is subject to polish finishing, the top level of compacted HPFRCC should be made slightly above the top of the mold.

1.5.4 Top surface finishing of specimens

1.5.4.1 Capping specimens

Capping of specimens should be performed as follows.

- a) The capping material should have good adhesion to HPFRCC without harmful effects.
- b) The compressive strength of the capping layer should not be lower than the expected compressive strength of HPFRCC.
- c) The capping layer should be made as thin as possible.
- d) The timing of capping should be determined according to the setting time, test purpose and age at the time of the test of the HPFRCC tested. When capping the specimen before demolding, it should be done at an appropriate timing between 2 and 48 hours after placement.

1.5.4.2 When giving polish finishing

Where the top surface is subject to polish finishing, it should be done without affecting the HPFRCC tested.

1.5.5 Permissible dimensional errors of specimens

Permissible dimensional errors of specimens should be pursuant to JIS A 1132.

1.6 Specimens for uniaxial tension tests

1.6.1 Dimensions of specimens

Dimensions of specimens should be pursuant to Fig.T1.6.1 and Table T1.6.1. Note that these criteria should be applied only to those specimens whose minimum size is at least the fiber length and twice the maximum aggregate size. For other specimens, a relevant uniaxial tensile test method should be established separately and the specimens should be produced based on that method.

1.6.2 Specimen production apparatus

The following provisions should be applied to apparatus for specimen production:.

- a) Molds should be made of non-water-absorbing materials and resistant to cement such as metal or plastics.
- b) Molds should be free from deformation and water leakage during production of specimens.
- c) Molds should be designed to ensure the precision required for the specimen to be produced.
- d) Appropriate form release agent or mineral oil may be applied on the internal surfaces of molds.
- e) When compacting with a mallet, the mallet should have a weight and dimensions capable of ensuring adequate compaction for the target HFRCC.
- f) When compacting with a vibration table, the table should have performance capable of ensuring adequate compaction for the target HFRCC.

1.6.3 Production of specimens

1.6.3.1 Using a mallet

Specimens should be produced in the same procedures (e.g. placement and spraying methods) as applied in the actual work, and the use of a tamping rod or an internal vibrator is prohibited. During placement, the material should be filled into the mold from a single direction without pausing to minimize entrapped air, and placement on the hardened material should be avoided. To compact the material filled, the sides of the mold should be hit with a mallet to reduce air voids and creating a smooth surface.

1.6.3.2 Using a vibration table

Specimens should be produced in the same procedures (e.g. placement and spraying methods) as applied in the actual work, and the use of a tamping rod or an internal vibrator is prohibited. During placement, the material should be filled into the mold from a single direction at one time to minimize entrapped air, and placement on the hardened material should be avoided. To reduce air voids, the mold should be stuck tightly to the vibration table to have enough vibration for compaction. The duration of compaction should be determined according to the properties of target HPFRCC and performance of vibrator ensuring adequate compaction. Care should be taken for excessive duration of compaction to avoid segregation of materials.

1.6.4 Permissible dimensional errors of specimens

Permissible dimensional errors of specimens should be pursuant to Table T1.6.1.

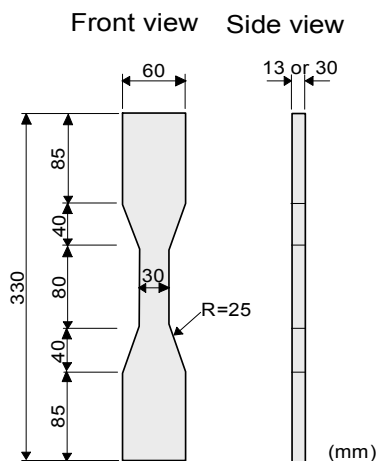


Fig. T1.6.1 Specimen for uniaxial tensile strength test

Table T1.6.1 Dimensions and permissible errors of specimens for uniaxial tensile strength test (Unit:mm)

	Parallel portion width	Original reference point distance	Parallel portion length	Thickness
Size	30	80	80	13 or 30
Permissible error	±1	±1	±1	±1

1.7 Demolding and curing

Demolding and curing should be as follows.

- a) Molds should be removed between 24 and 48 hours after placement.
- b) After casting, specimens should be properly treated, e.g. by covering their top surface with glass plates until demolding.
- c) After casting, specimens should be cured according to the specific test purpose.

Testing Method 2: Testing Method of Uniaxial Tensile Strength

2.1 Scope

This standard prescribes the method of evaluating the tensile yield strength, tensile strength and ultimate tensile strain of High Performance Fiber Reinforced Cement Composites with Multiple Fine Cracks (HPFRCC) by uniaxial tension tests.

2.2 Referenced standard

The standard cited below forms a part of this standard through herein referenced. The latest version of referenced standard should be applied.

Testing Method 1: Preparation of specimens for strength tests.

2.3 Apparatus

Testing machines and apparatus should be as follows.

- a) The testing machine for the tensile test should be of Grade 1 of JIS B 7721 or higher and should allow displacement-controlled loading.
- b) The test machine should ensure the alignment between chucks be properly vertical.
- c) The apparatus measuring the displacement between reference points should have a precision of 1/1000mm or higher and not restrict any deformation between the reference points.
- d) The chucking mechanism should fit to the specimen shape and test load, and is designed to allow tensile loading along the specimen's central axis. The specimen should be placed in the test machine with a chuck on both ends, a fixed support on one end and a pin (hinge) support on the other end.

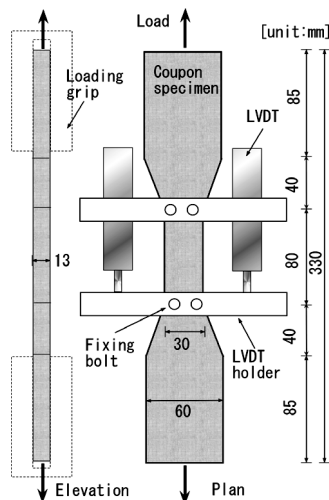


Fig. T2.3.1 Outline of uniaxial tension test

As examples of chucking mechanism, test machines with a pneumatic chuck and clamp jigs are shown in Figs. T2.3.2 and T2.3.3.



(a) Fixed load end

(b) Pin supported load end

Fig. T2.3.2 Example of pneumatic chucking mechanism



(a) Fixed load end

(b) Pin supported load end

Fig. T2.3.3 Example of clamp-jig chucking mechanism

2.4 Specimens

The shape, dimensions and production method of specimens should be pursuant to those specified for uniaxial tensile tests prescribed in “Testing Method 1: Preparation of specimens for strength tests”.

2.5 Test method

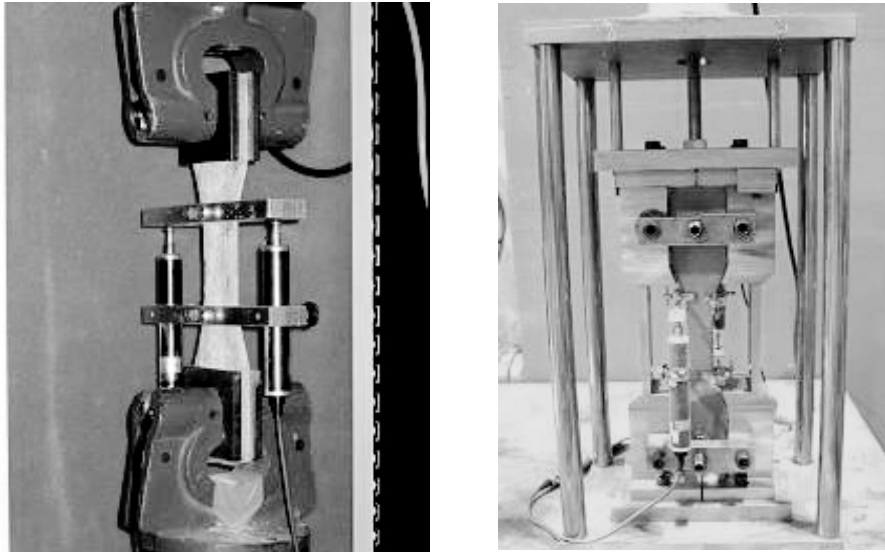
Tests should be carried out as follows.

a) The load should be applied using a chucking mechanism suited to the shape of the specimen.

Figure T2.5.1 shows test conditions with different chucking mechanisms.

b) The load should be applied at a constant specimen deformation rate of approximately 0.5mm per minute.

c) At least five specimens should be tested.



(a) Pneumatic chucking mechanism (b) Chucking mechanism using clamp jigs

Fig. T2.5.1 Example of tests with different chucking mechanisms

2.6 Calculation

The initial sectional area of the test zone, reference point distance, yielding point, tensile yield strength, ultimate tensile strain, maximum stress in the strain-hardening region and tensile strength should be obtained in the following procedure:

- a) The initial sectional area of the test zone is obtained as the mean value of three sections at both ends and the center of the reference points.
- b) The reference point distance should be measured with a proper measuring instrument.
- c) The test value of tensile yield strength f_{tyi} (N/mm²) is given by

$$f_{tyi} = \frac{F_{ty}}{A_0} \quad (T2.6.1)$$

where,

F_{ty} : Load at the yielding point ⁽¹⁾ (N)

A_0 : Initial sectional area of test zone of specimen (mm²)

Note (1) Yielding point: A point representing the minimum load, which is found between the initial cracking point and the softening starting point ⁽²⁾ on the line joining convex inflection points, where stress changes from increase to decrease, in the stress-strain relationship obtained in tensile tests on specimens.

Note (2) Softening starting point: In a direct uniaxial tension test on HPFRCC, the tensile load shows a gradual increase after the initial cracking accompanied by the development of multiple micro cracks. After these multiple micro cracks develop, the tensile stress decreases rapidly showing an increase in width of certain cracks. The point at which the load starts reducing associated with the increase in crack

width is defined as the “softening starting point”. In the stress-strain relationship obtained in tensile tests on specimens, the softening starting point is an inflection point immediately before the stress finally stops increasing.

d) The test value of maximum stress in the strain-hardening region f_{pshi} (N/mm²) is given by

$$f_{pshi} = \frac{F_{psh}}{A_0} \tag{T 2.6.2}$$

where,

F_{psh} : Maximum load (N) in the strain region between the yielding point and softening starting point.

e) The test value of tensile strength f_{ti} (N/mm²) is given by

$$f_{ti} = \frac{F_t}{A_0} \tag{T 2.6.3}$$

where,

F_t : Maximum load (N)

f) The strain at the softening starting point is defined as the ultimate tensile strain, whose test value ϵ_{tui} (%) is given by

$$\epsilon_{tui} = \frac{l_u - l_0}{l_0} \times 100 \tag{T2.6.4}$$

where,

l_u : Reference point distance at the ultimate point (mm)

l_0 : Original reference point distance (mm)

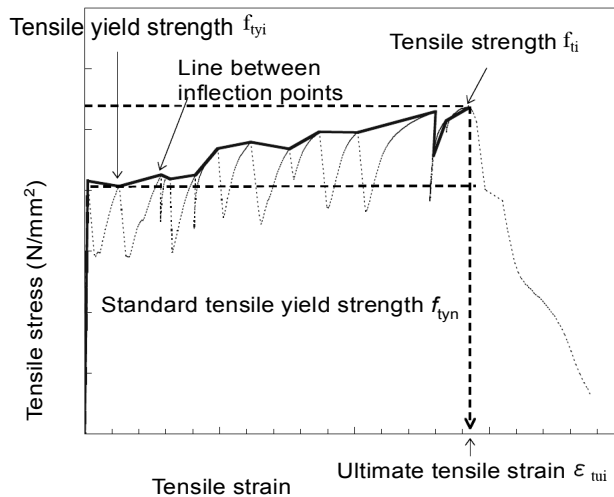


Fig. T2.6.1 Yielding point, ultimate point and tensile strength

g) The tensile yield strength, ultimate tensile strain, maximum stress in the strain-hardening region and tensile strength are derived from the mean values of 3 or more specimens excluding those that showed the maximum and minimum ultimate tensile strain. However, all

the results of tests performed should be used for calculating dispersion, such as the coefficient of variation for the tensile yield strength, ultimate tensile strain, maximum stress in the strain-hardening region and tensile strength.

2.7 Reporting

Reports should include necessary subjects among the following:

- a) Date/month/year of the tests
- b) Specimen symbols
- c) Width and thickness of the parallel portion of test zone of specimens (mm)
- d) Date of specimen production and material age of the specimens
- e) Maximum load (N)
- f) Tensile yield strength (N/mm^2)
- g) Maximum stress in the strain-hardening region (N/mm^2)
- h) Tensile strength (N/mm^2)
- i) Ultimate tensile strain (%)

Testing Method 3: Testing Method of Crack Width of HPFRCC (Average and Maximum Crack Widths)

3.1 Scope

This standard prescribes the method of measuring the maximum value of cracks induced during uniaxial tensile tests on High Performance Fiber Reinforced Cement Composites with Multiple Fine Cracks (HPFRCC). The standard is applied to cases where the crack dispersiveness of HPFRCC is evaluated in terms of the average and maximum crack widths. In carrying out the test prescribed here, a test for static modulus of elasticity pursuant to JIS A 1149 should be performed on the same material to obtain Young 's modulus.

3.2 Referenced standards

The standards cited below form a part of this standard through herein referenced. The latest versions of referenced standards should be applied.

Testing Method 1: Preparation of specimens for strength tests

Testing Method 2: Testing method of uniaxial tensile strength

JIS A 1149: Method of test for static modulus of elasticity of concrete

JIS Z 8401: Rules for rounding off of numerical values

3.3 Apparatus

Test machines and apparatus should be pursuant to “Testing Method 2: Testing method of uniaxial tensile strength”.

3.4 Specimens

In addition to the provisions prescribed in “Testing Method 1: Preparation of specimens for strength tests”, specimens should satisfy the followings:

- a) The shape, dimensions and production method of specimens should be pursuant to “Testing Method 1: Preparation of specimens for strength tests” ⁽¹⁾.

Note (1): The age of specimens to be tested should be 4 weeks in principle, which may be changed appropriately to suit the specific test purpose.

- b) Specimens should be ready for tests immediately after completion of the required curing time⁽²⁾.

Note (2): Tests should be carried out after completion of curing because the strength of HPFRCC may sometimes change considerably depending on the moisture content of specimen and ambient relative humidity.

- c) The center line in the test zone of specimens should be marked in advance.

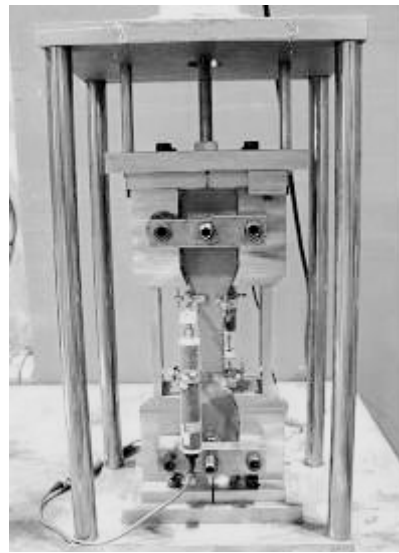
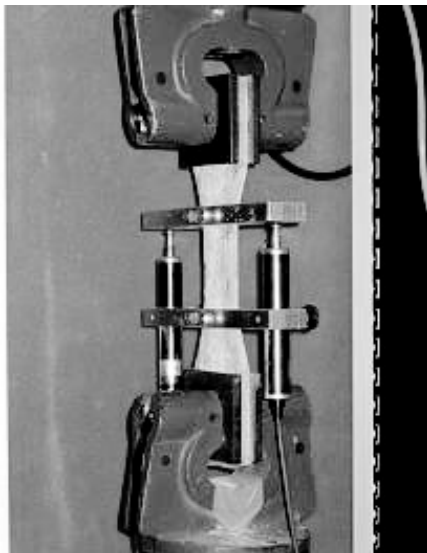
3.5 Testing method

Tests should be carried out as follows.

- a) The load should be applied using a chucking mechanism suited to the shape of specimens shown in Fig. T3.5.1.
- b) To measure the strain in the test zone, displacement transducers should be fixed to the specimen with jigs.
- c) The load should be applied at a constant speed to induce deformation without giving any impact shock on the specimen. The deformation rate should be approximately 0.5mm per minute.
- d) The load should be applied until the specimen reaches the required deformation level ⁽³⁾.

Note (3): The “required deformation level” is an amount of displacement representing the characteristic value of ultimate tensile strain.

- e) At least five specimens should be tested.



(a) Pneumatic chucking mechanism

(b) Chucking mechanism using clamp jigs

Fig. T3.5.1 Example of tests with different chucking mechanisms

3.6 Calculation

The average and maximum crack widths should be obtained as follows.

- a) Average crack width μ_w should be obtained by either of the following methods:
- b) Using (T3.6.1) based on the number of cracks:

Once the strain of specimen has reached the characteristic value of ultimate tensile strain ϵ_{tuk} , the specimen is unloaded to retain the strain level. The number of surface cracks developed in the test zone N_c is measured along the central axis by visual observation. Stress on the

sectional area of specimen $\sigma_{t_{ui}}$, which corresponds to $\varepsilon_{t_{uk}}$, is also recorded.

$$\mu_w = \frac{80 \left(\varepsilon_{t_{uk}} - \frac{\sigma_{t_{ui}}}{E_c} \right)}{N_{cr}} \quad (T3.6.1)$$

c) Using (T3.6.2) based on the direct measurement of crack width

When the strain of specimen has reached the characteristic value of ultimate tensile strain $\varepsilon_{t_{uk}}$, the specimen is unloaded to retain the strain level. With a method capable of measuring crack width at a precision of 0.01mm or higher, the width of every crack w_i is measured at the intersection between the central axis and each crack.

$$\mu_w = \frac{1}{N} \sum_{i=1}^N w_i \quad (T3.6.2)$$

where w_i : crack width measured when the strain has reached the characteristic value of ultimate tensile strain $\varepsilon_{t_{uk}}$, N : number of measurement value samples of crack width measured when the strain has reached the characteristic value of ultimate tensile strain $\varepsilon_{t_{uk}}$.

d) The confidence limit value of crack width w_{lim} is given by

$$w_{lim} = \mu_w (1 + 1.645 \delta_w) \quad (T3.6.3)$$

where δ_w : coefficient of variation of crack width derived from "Testing Method 4: Testing method of crack width of HPCFRCC (Variation of crack width)" or actual data available

e) The average crack width and the maximum crack width are calculated by leveling off the value of μ_w and w_{lim} of each specimen measured, respectively.

3.7 Reporting

Reports should include necessary subjects among the following:

- a) Date/month/year of the tests
- b) Specimen labelling
- c) Width and thickness of the parallel portion of test zone of specimens (mm)
- d) Date of specimen production and material age of the specimens
- e) The characteristic value of ultimate tensile strain adopted, sectional stress at the time when the strain has reached the characteristic value of ultimate tensile strain (N/mm^2) and Young's modulus
- f) Number of cracks when the strain has reached the characteristic value of ultimate tensile strain, average crack width and confidence limit value of crack width
- g) Average crack width (mm)
- h) Maximum crack width (mm)

Testing Method 4: Testing Method of Crack Width of HPFRCC (Variation of Crack Width)

4.1 Scope

This standard prescribes the method of evaluating the crack width variability of High Performance Fiber Reinforced Cement Composites with Multiple Fine Cracks (HPFRCC) in terms of the coefficient of variation of crack width when the strain has reached the characteristic value of ultimate tensile strain.

4.2 Referenced standards

The standards cited below form a part of this standard through herein referenced. The latest version of referenced standard should be applied.

Testing Method 1: Preparation of specimens for strength tests

Testing Method 2: Testing method of uniaxial tensile strength

4.3 Apparatus

Test machines and apparatus shall be pursuant to "Testing Method 2: Testing method of uniaxial tensile strength".

4.4 Specimens

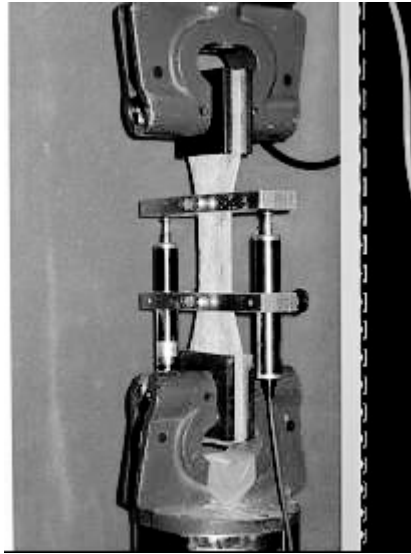
The shape, dimensions and production method of specimens should be pursuant to those specified for uniaxial tension tests in "Testing Method 1: Preparation of specimens for strength tests".

4.5 Test method

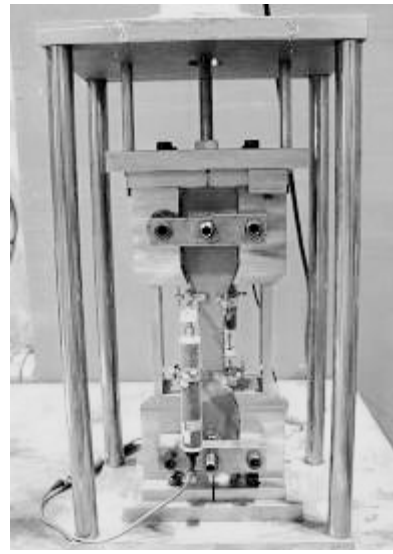
4.5.1 Test method

Tests should be carried out as follows.

- a) The load should be applied using a chucking mechanism suited to the shape of the specimens.
- b) The load should be applied at a constant specimen deformation rate of approximately 0.5mm per minute.
- c) The number of specimens subjected to crack width measurement should be five or more, except for specimens specified in 4.5.2-b).



(a) Pneumatic chucking mechanism



(b) Chucking mechanism using clamp jigs

Fig. T4.5.1 Example of tests with different chucking mechanisms

4.5.2 Method of crack width measurement

Crack width should be measured as follows.

- a) Once the strain of a specimen has reached a level corresponding to the characteristic value of ultimate tensile strain ε_{tuk} , the specimen is unloaded to retain the strain level.
- b) Any specimen that is broken before the strain has reached the characteristic value of ultimate tensile strain ε_{tuk} should be excluded from crack width measurement.
- c) While retaining the characteristic value of ultimate tensile strain ε_{tuk} after unloading, the width of every crack w_i is measured at the intersection of the central axis and each crack by a measurement method capable of measuring crack width at a precision of 0.01mm or higher.

4.6 Calculation

The coefficient of variation δ_w should be calculated with (T4.6.1) using the width of every crack in the specimens tested.

$$\delta_w = \frac{\sigma_w}{\mu_w} \quad (\text{T4.6.1})$$

where,

$$\sigma_w = \sqrt{\frac{1}{(N-1)} \sum_{i=1}^N (w_i - \mu_w)^2}$$

$$\mu_w = \frac{1}{N} \sum_{i=1}^N w_i$$

w_i : measured value of crack width when the strain has reached the characteristic value of

ultimate tensile strain ε_{tik} , N : Number of measurement of crack width measured when the strain has reached the characteristic value of ultimate tensile strain ε_{tik}

4.7 Reporting

Reports should include necessary subjects among the following:

- a) Date/month/year of the tests
- b) Specimen labelling
- c) Width and thickness of the parallel portion of test zone of specimens (mm)
- d) Date of specimen production and material age of the specimens
- e) The characteristic value of ultimate tensile strain adopted and sectional stress when the strain has reached the characteristic value of ultimate tensile strain (N/mm^2);
- f) Measured values of crack width (mm), number of crack width measurement, average measured value of crack width (mm) and standard deviation of measured values of crack width (mm)
- g) Coefficient of variation of crack width.